

*Gas Detection  
Transmitter*



P/N: 77036007-1

Revision: 6.3

Reference Firmware: 3.01 (wired rev. 3.2)

Reference Firmware: 3.09 (wireless rev. 1.3)

Reference Firmware: 3.09 (wireless rev. 2.4)

Copyright © Feb-2015 by Oldham S.A.S.

All rights reserved. No reproduction of all or part of this document, in any form, is permitted without the written consent of Oldham S.A.S.

All of the information that is provided in this document is accurate to the best of our knowledge.

As a result of continuous research and development, the specifications of this product may be changed without prior notice.

Oldham S.A.S  
Rue Orfila  
Z.I. Est – C.S. 20417  
F-62027 ARRAS Cedex  
Tel.: +33 (0)3 21 60 80 80  
Fax: +33 (0)3 21 60 80 00  
[www.oldhamgas.com](http://www.oldhamgas.com)

**THE INFORMATION CONTAINED IN THIS MANUAL IS ACCURATE TO OUR KNOWLEDGE.**

As a result of continuous research and development, the specifications of this product may be modified at any time without prior notice.

**IMPORTANT INFORMATION**

The modification of the material and the use of parts of an unspecified origin shall entail the cancellation of any form of warranty.

The use of the unit has been projected for applications specified in the technical characteristics. Exceeding the values cannot in any case be authorized.

**LIABILITY**

Neither Oldham nor any other associated company can be held liable for any damages, including, without limitations, damages for the loss or interruption of manufacture, loss of information, defect of the OLCT 200 unit, injuries, loss of time, financial, or material loss, or any direct or indirect consequence of loss occurring in the context of the use or impossibility of use of the product, even in the event that Oldham has been informed of such damage.

**SAFETY INSTRUCTIONS**

Labels intended to remind you of the principal precautions of use have been placed on the unit in the form of pictograms. These labels are considered an integral part of the unit. If a label falls off or becomes illegible, see to it that it is replaced.







**Warning: Read & understand contents of this manual prior to operation. Failure to do so could result in serious injury or death.**



# Table of Contents

<b>SECTION 1 - SAFETY INFORMATION .....</b>	<b>7</b>
1.1 Safety Information – Read Before Installation & Applying Power .....	7
<b>SECTION 2 - INSTALLATION INSTRUCTIONS .....</b>	<b>9</b>
2.1 Introduction.....	9
2.2 Ratings and Certifications.....	11
2.3 Sensor Location.....	11
2.4 Mounting the Enclosure.....	11
2.5 System Design Specifications .....	16
2.6 Field Wiring Installation .....	17
2.7 Alarms / RS-485 Modbus 10-0234 Option Installation.....	25
2.8 Isolated 4-20mA Output 10-0250 Option .....	26
2.9 HART Communication 10-0351 Option .....	27
2.10 Sensor Installation .....	30
2.11 “Sensor Type” and OLCT 200 Signal Conditioning.....	31
<b>SECTION 3 - INITIAL START-UP .....</b>	<b>33</b>
3.1 “Transmitter Configuration” Menu.....	33
3.2 Initial Bridge Sensor Monitor Start-Up .....	34
3.3 Initial Toxic / Oxygen Sensor Monitor Start-Up.....	35
<b>SECTION 4 - OPERATING INSTRUCTIONS .....</b>	<b>37</b>
4.1 Routine Sensor Calibrations.....	37
4.2 ALARM OPERATION .....	40
<b>SECTION 5 - SETUP MENU CONFIGURATION.....</b>	<b>41</b>
5.1 Menus Database Configuration .....	41
5.2 Configuration Using the Magnetic Wand .....	42
5.3 System Configuration Menus .....	43
5.4 Alarm Settings .....	46
5.5 Sensor Information .....	47
5.6 CLOCK/DELAY SETUP .....	48
5.7 LCD Contrast Adj.....	49
5.8 HELP Screen.....	49
5.9 Diagnostics.....	49
5.10 RS-485 / MODBUS SETUP.....	50
5.11 SYSTEM SECURITY.....	54
<b>SECTION 6 - WIRELESS COMMUNICATION.....</b>	<b>55</b>
6.1 Description of Client and Server Wireless Networks .....	55

6.2	OLCT 200 Radio Status (RS) Icons Zzz's,  ,  ,  ,  , 	55
6.3	RF Comm Cycle and Power Consumption	56
6.4	#10-0299 OLCT 200 Battery I/O PCB with Power Switch	57
6.5	WIRELESS COMMUNICATION SETUP	57

**SECTION 7 - TECHNICIANS ONLY MENUS ..... 63**

7.1	Introduction	63
7.2	Set Balance / Set Sensor Voltage (Technicians only!)	64
7.3	Set Gain to Unity (Technicians only!)	65
7.4	PreAmp Gain Adjust (Technicians only!)	65
7.5	Zero Cal Value (Technicians only!)	66
7.6	Raw Min / Max Counts (Technicians only!)	66

**SECTION 8 - ARCTIC CONFIGURATIONS ..... 67**

8.1	ARCTIC Option	67
-----	---------------	----

**SECTION 9 - SENSORS ..... 69**

9.1	Catalytic Bead (LEL) Sensors	69
9.2	Infrared (IR) Sensors	69
9.3	Photoionization Detection (PID) Sensors	72
9.4	Electrochemical Sensors	76
9.5	Spare Sensors	77

# SECTION 1 - SAFETY INFORMATION

## 1.1 Safety Information – Read Before Installation & Applying Power

### IMPORTANT

Users should have a detailed understanding of OLCT 200 operating and maintenance instructions. Use the OLCT 200 only as specified in this manual or detection of gases and the resulting protection provided may be impaired. Read the following **WARNINGS** prior to use.

### WARNINGS

- Calibrate with known target gas at start-up and check on a regular schedule, at least every 90 days. More frequent inspections are encouraged to spot problems such as dirt, oil, paint, grease or other foreign materials on the sensor head.
- Do not paint the sensor assembly or the transmitter.
- Do not use the OLCT 200 if its enclosure is damaged or cracked or has missing components.
- Make sure the cover, internal PCB's and field wiring are securely in place before operation.
- Use only a sensor assembly compatible with the OLCT 200 and approved by Oldham. (See the section 9.5 for Replacement Parts.)
- Periodically test for correct operation of the system's alarm events by exposing the monitor to a targeted gas concentration above the High Alarm set point.
- Do not expose the OLCT 200 to electrical shock or continuous severe mechanical shock.
- Protect the OLCT 200 from dripping liquids and high power sprays.
- Use only for applications described within this manual.
- Oxygen deficient atmospheres may cause combustible gas readings that use catalytic LEL sensors to be lower than actual concentrations.
- Oxygen enriched atmospheres may cause combustible gas readings that use catalytic LEL sensors to be higher than actual concentrations.
- Calibrate the catalytic combustible gas sensor after each incident where the combustible gas content causes the instrument to enter in the OVER-RANGE alarm condition.
- Silicone compound vapors may affect the catalytic combustible gas sensor and cause readings to the combustible gas to be lower than actual gas concentrations. If the sensor has been used in an area where silicone vapors were present, always calibrate the instrument before continued use to ensure accurate measurements.
- Sensor openings must be kept clean. Obstruction of the sensor openings may cause readings to be lower than actual gas concentrations.
- Sudden changes in atmospheric pressure may affect gas readings.

**CALIBRATION ALERT: Gas detection instruments are potentially life-saving devices. Recognizing this fact, calibration for the toxic, catalytic LEL and PID sensors should be at least at quarterly intervals, while the infrared sensor should be calibrated on an annual basis with functional test every 6 months.**

Further, Oldham recommends prudent testing including calibration after a gas alarm. All calibration service to sensors should be recorded and accessible.

**CAUTION: FOR SAFETY REASONS THIS EQUIPMENT MUST BE OPERATED AND SERVICED BY QUALIFIED PERSONNEL ONLY. READ AND UNDERSTAND INSTRUCTION MANUAL COMPLETELY BEFORE OPERATING OR SERVICING.**

**ATTENTION: POUR DES RAISONS DE SÉCURITÉ, CET ÉQUIPEMENT DOIT ÊTRE UTILISÉ, ENTRETENU ET RÉPARÉ UNIQUEMENT PAR UN PERSONNEL QUALIFIÉ. ÉTUDIER LE MANUE D'INSTRUCTIONS EN ENTIER AVANT D'UTILISER, D'ENTRETENIR OU DE RÉPARER L'ÉQUIPEMENT.**



# SECTION 2 - INSTALLATION INSTRUCTIONS

## 2.1 Introduction

**Important:** This manual describes the 2-Wire 4-20mA, the 3-Wire 4-20mA and the wireless versions of the OLCT 200. 2-Wire versions are only possible if the 10-0232 Display PCB IS THE ONLY PCB IN THE ENCLOSURE. If the 10-0233 I/O Power Supply is installed it is a 3-Wire version. Wireless versions include a battery powered version that can be used for electrochemical sensors or a 10-30VDC powered wireless version that can use all OLCT 200 sensor types.

The OLCT 200 is a single or dual channel fixed-point monitor designed to provide continuous monitoring of hazardous gases in the workplace. 2-wire and wireless models are only single channel. Monitored values are displayed in their engineering units as well as graphically as a bar graphs or 30-minute trends (Figure 2.1). Input types include Electrochemical toxic / oxygen sensors, catalytic bead combustible sensors, Infrared sensors, as well as Photoionization Detection (PID) sensors. Sensors supplied by the factory include an 8-wire *Smart Sensor* interface capable of configuration data uploads to the OLCT 200. Its advanced microcontroller electronics and superior graphic LCD operator interface offers enhanced diagnostics and fault analysis not possible in competing products. The wired OLCT 200 models provides a standard 4-20 mA output signal for connection to control systems or other alarm instrumentation. Available options include an Alarm Relay / RS-485-Modbus board, an Isolated 4-20mA output board, and a HART Communication board. Wireless models do not accept additional option boards. Non-volatile memory retains all configuration data during power interruptions. The magnetic, non-intrusive calibration can be easily performed by one person without opening the enclosure. A standard “real time clock & calendar” feature allows data logging of calibrations and alarm events for recall to the LCD readout or over the serial port.

The OLCT 200 wireless models functions on license free 900MHZ or 2.4GHZ wireless Client / Server networks. Wireless data can be directly transmitted to Oldham WX4, WX16 and WX64 Controllers. Controllers must be equipped with the matching RF wireless modem and appropriate antenna to receive the transmissions.

Toxic and oxygen monitors are capable of 2-wire 4-20mA operation (section 2.6.1) when the alarms / Modbus option and LCD backlight are not required. Catalytic LEL, Infrared, and PID sensors, or addition of any option board, require the 10-0233 I/O Power Supply board providing 3-wire 4-20mA operation (section 2.6.3). Only periodic calibration checks are needed to assure dependable performance. Operator interface is very intuitive with the LCD displaying data both graphically as bar-graphs / trends and in engineering units (Figure 2-1). Additional features include:

- No potentiometer or jumper settings required. All setup is with menus accessed via the LCD / magnetic keypad operator interface without opening the enclosure.
- Field adjustable alarm levels may be high, low, fault, fail-safe, latching and acknowledgeable.
- New alarms cause front LED's to flash and become steady after acknowledge.
- CAL MODE advises when to apply gas during calibrations
- One half hour trend screen shows rate of change of gas exposures
- Sensor life bar-graph updates after each SPAN calibration.
- Modular design affords efficient installation and plug in sensors allow changing target gases after installation
- New smart sensors are recognized by the OLCT 200 and prompts users to either upload new configuration data or continue with data from the previous smart sensor.
- Missing Sensors trip the "FAIL" alarm.
- Sensors are industry proven for fast response and long life.
- On screen radio status icons indicate "Server In Range", "Server Out of Range", Server Previously Out of Range" and "Low Battery" conditions.

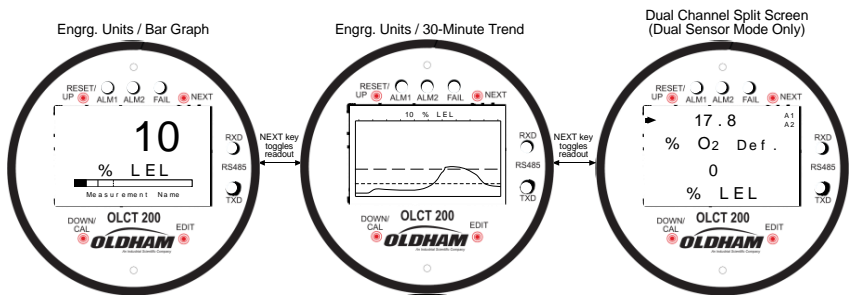

Figure 2-1a: Data Displays – 2 Wire and 3 Wire Models

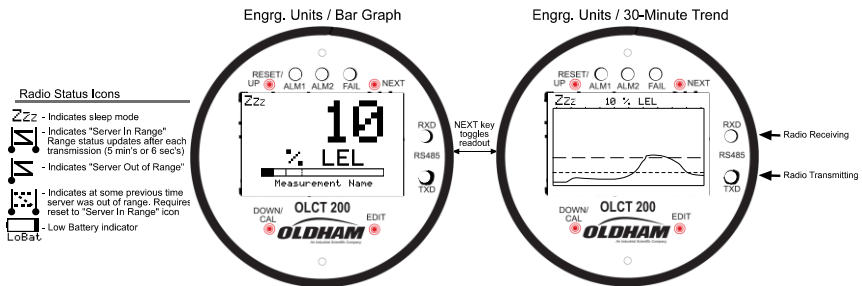

Figure 2-1b: Data Displays – Wireless Models

## 2.2 Ratings and Certifications

### Wired Models

CSA certified for Division 1 & 2 hazardous area installations for explosion proof Class 1 Groups B,C,D, and intrinsically safe (OLCT 200/EC 2-wire loops only) Class 1 Groups A,B,C,D. Also see sections 2.7, 2.7a & 2.8. Designed to meet CSA C22.2 No.152 for Combustibles Monitors and ISA 92.0.01 Part 1 for Toxic Monitors.

### Wireless Models

The enclosure is NRTL certified for Division 1 hazardous area installations for explosion-proof Class 1 Groups B,C,D (see Figure 2-2c). The OLCT 200 is designed to meet ISA 92.0.01 Part 1 for Toxic Monitors. The 10-0295 antenna fitting has an RP-SMA connector and is suitable for Division 2 classified areas. An optional 1000-2193 antenna is also available for Division 1 classified areas. Figure 2-8 shows both antenna styles.

## 2.3 Sensor Location

Factors such as air movement, gas density in relation to air, emission sources and environmental variables affect correct sensor location. Air movement by fans, prevailing winds and convection should be carefully evaluated to determine if a leak is more likely to raise gas levels in certain areas within the facility. Vapor density of a gas determines if it will rise or fall in air when there are no significant currents. Lighter than air gases should have the monitors mounted 12 – 18 inches (30 – 45 centimeters) above the potential gas leak and heavier than air gases should be this distance below. Even though the OLCT 200 is designed for rugged service, sensors should be protected from environmental damage from water, snow, shock, vibration and dirt.

## 2.4 Mounting the Enclosure

The OLCT 200 standard enclosure is a cast aluminum explosion-proof (NEMA 7) enclosure as shown in Figure 2-2. Figure 2-2a shows dimensions with the dual local sensor 'Y' included. Figure 2-2c shows the wireless model. For wireless models, the wireless antenna should typically be mounted with "line of sight" access to the controller's base station antenna. If a good "line of sight" angle is not possible the OLCT 200 will usually still function properly at ranges up to 1500 feet but obstructions should be kept to a minimum.

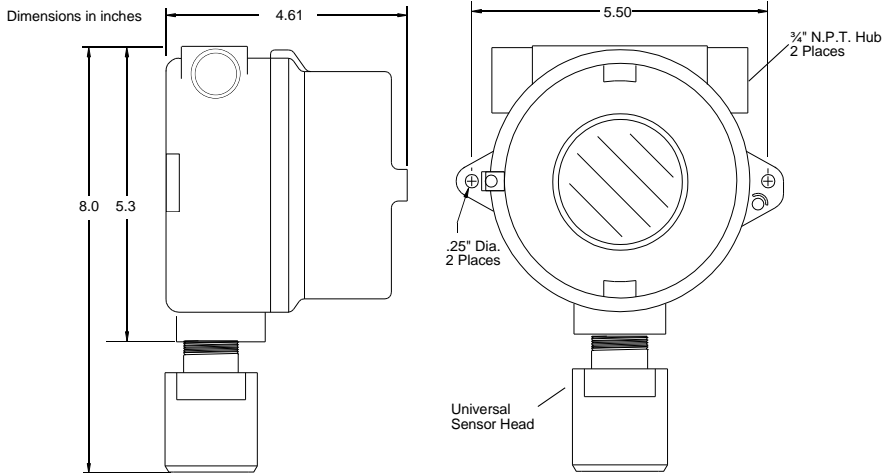

**Figure 2-2a: OLCT 200 Explosion-Proof Housing**

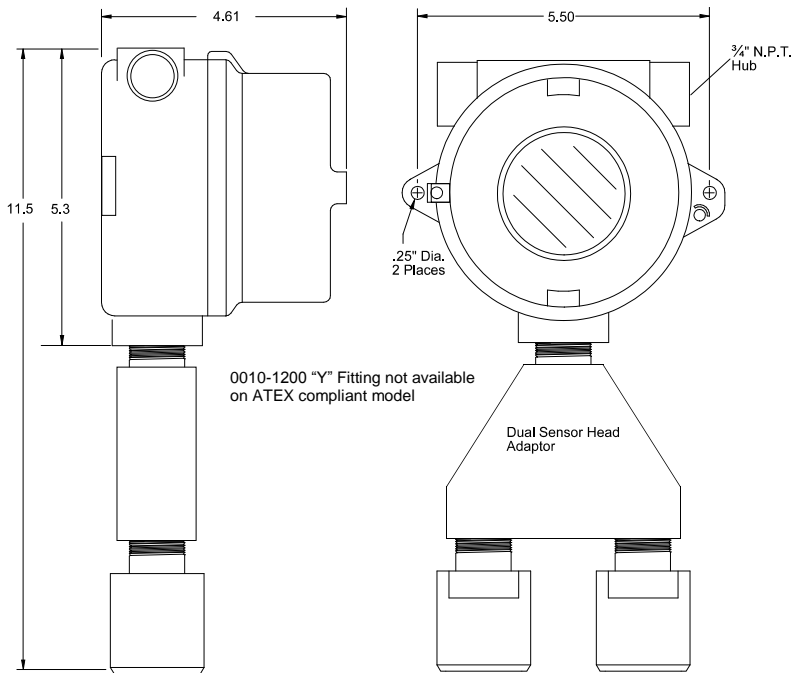

**Figure 2-2b: OLCT 200 Explosion-Proof Housing with Dual Sensor Head Adaptor**

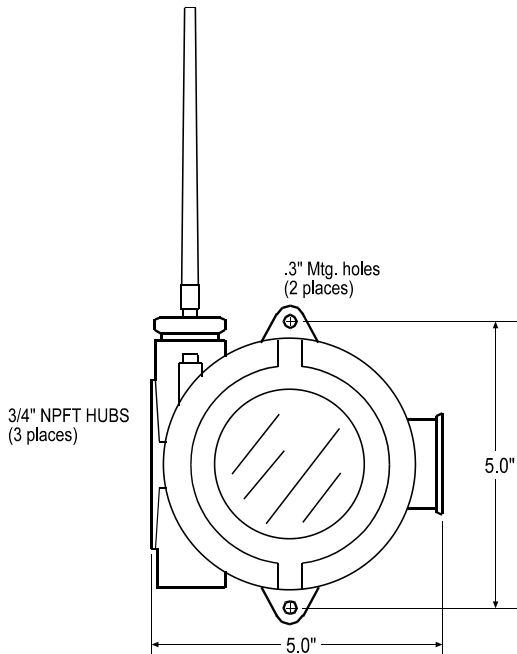
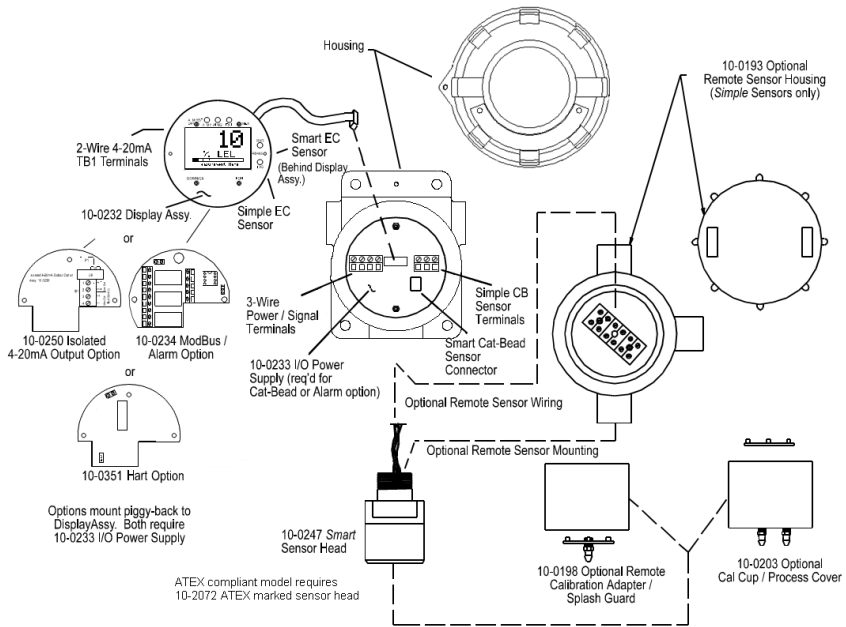

**Figure 2-2c: OLCT 200 Wireless Explosion-Proof Housing**

Modular design simplifies the installation of the OLCT 200 (Figure 2-3). A top Display Assembly is mounted with captive thumbscrews and is easily removed to access field-wiring terminals. An optional 10-0234 Alarms/Modbus board mounts *piggyback* to the back of the Display Assembly. Wiring from toxic or oxygen sensors terminates at the 10-0232 Display Assembly along with 2-wire 4-20mA signal wires. This Display Assembly is the only PC board supplied with toxic / oxygen OLCT 200s not requiring relays, RS-485 Modbus, HART or LCD backlight. The optional bottom 10-0233 I/O Power Supply board generates voltages needed for LCD backlight, relays, RS-485 Modbus, HART and Bridge sensor and is required with any of these I/O functions. The enclosure is equipped with two threaded 3/4 inch NPT conduit fitting outlet and pre-drilled mounting flanges.

**WARNING:** Qualified personnel should perform the installation according to applicable electrical codes, regulations and safety standards. Insure correct cabling and sealing fitting practices are implemented. Do not aim the sensor pointing upward. Install the OLCT 200 to a wall or bracket using the predrilled mounting flanges with I.D. 0.25 on 5.5 inch centers (Figure 2-2). If conduit is rigid and able to support the weight of the OLCT 200, the mounting bolts may be omitted.

**CAUTION:** The sensor should never be installed pointing upwards.



**Figure 2-3a: Outline Drawing – OLCT 200 Wired Models**

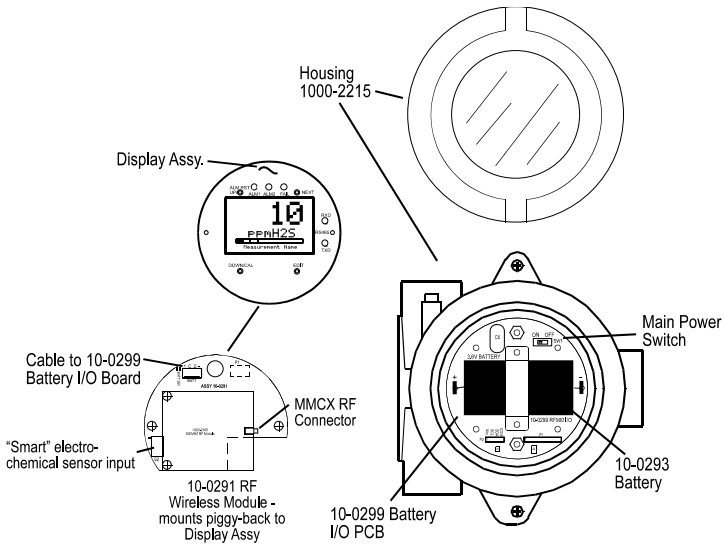

**Figure 2-3b: Outline Drawing – OLCT 200 Battery Powered Wireless Models**

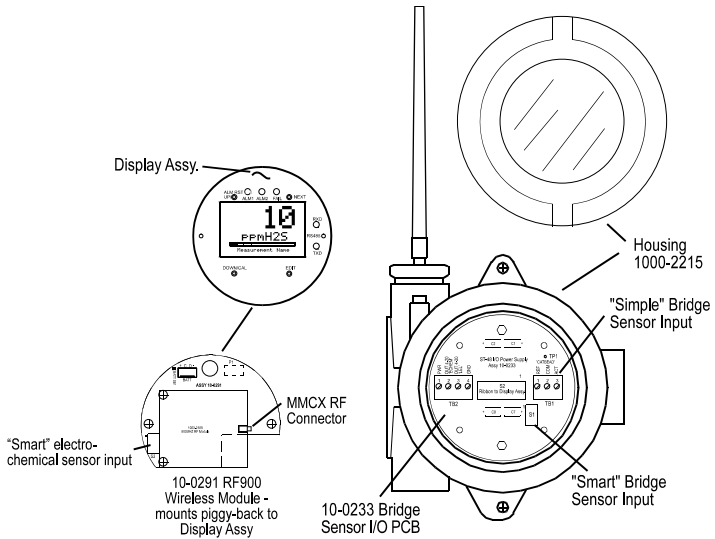

**Figure 2-3c: Outline Drawing – OLCT 200 10-3VDC Powered Wireless Models**

### 2.4.1 10-0322 Magnetic Mounting Option

The 10-0322 Magnetic Mount securely attaches the assembly to solid steel structure that is at least 6 inches wide.

## 2.5 System Design Specifications

### Supply Voltage:

2 Wire Model	3 Wire Model	10-30VDC Wireless Model	Battery Powered Wireless Model
10-30VDC	10-30VDC	10-30VDC	Integral non-rechargeable 3.6volt 19AH lithium D cell battery. Replacement P/N 10-0293.

### Power Consumption:

2 Wire Model	3 Wire Model	10-30VDC Wireless Model	Battery Powered Wireless Model
25mA max @ 24VDC	100mA @ 24VDC with 0.5watt sensor. Relays: +40mA per relay (120mA for three energized relays) RS-485: +20mA	<20mA - "sleep" mode 60mA – "receive beacon" mode Up to 1amp – 1 watt "transmit" mode. Transmit power can be set from 10mW – 1W.	<2mA - "sleep" mode 40mA – "receive beacon" mode Up to 1amp – 1 watt "transmit" mode. Transmit power can be set from 10mW – 1W.

### Loop Resistance at nominal 24 VDC power:

2 Wire Model	3 Wire Model	10-30VDC Wireless Model	Battery Powered Wireless Model
650 ohms	750 ohms	n/a	n/a

### Memory:

Non-volatile E2 memory retains configuration values in the event of power outages.



**Relays (Optional):**

Three configurable form C (SPDT) relays rated for 5 amp at 30 VDC or 240 ~VAC RESISTIVE.

Relay 1 and Relay 2 level alarms are configurable for HIGH or LOW trip, for normally energized (Failsafe) or normally de-energized and for latching or non-latching.

Relay 3 is always normally energized for failsafe operation so loss of power to the OLCT 200 will be indicated as a "FAULT" condition.

**CAUTION:** Relays are rated for RESISTIVE loads. Inductive loads, such as contactor coils or motors may cause contact arcing, which emits RFI into the sensor signals. Use appropriate snubbers and MOV's across inductive loads and keep wiring away from signal wires.

**Wireless Specifications:**

	900MHz Models	2.4GHz Models
Transmit (TX) Power	30dBm at 1W power. Transmit power may be set from 10mW to 1W.	50mW
Receive (RX) Sensitivity	-100dBm	-90dBm
Radio Frequency	Hopping between 902 – 928MHz.	Hopping between 2.4 – 2.5 GHz

## 2.6 Field Wiring Installation

**4-20mA Transmission Range Info:**

The distance 4-20 mA signals can travel is dependent upon several factors including the cable gauge, DC power supply voltage level and impedance of the input of the receiving device. Assuming a nominal 24 VDC power supply, maximum total loop resistance is 650 ohms in the 2-wire mode.

**Note:** WX16 Controllers have 4-20mA input resistance of 100 ohms.

### 2.6.1 2-Wire 4-20mA Intrinsically Safe & Explosion Proof Installations

OLCT 200's equipped with 10-0247 sensor heads are NRTL (Nationally Recognized Testing Lab) certified as suitable for both intrinsically safe and explosion proof installations. OLCT 200's equipped with 10-0247IS sensor heads (XP flame arrestor is not installed to allow monitoring of highly reactive gases such as Hydrogen Chloride or Ammonia) are NRTL certified as suitable for intrinsically safe installations. All OLCT 200's are NRTL certified for explosion proof installations as long as the sensor head is CSA certified as explosion proof. Follow instructions on Installation Drawing # 11-0100 in section 2.6.2 for correct intrinsically safe installations.

**Description:**

The 2-wire current sinking transmitter is the easiest and most economical to install since there are only two wires. All of the power needed comes from the current loop

and wire sizes may be smaller. However, only very low power applications are eligible for such transmitters. The OLCT 200 Display assembly shown in Figure 2-4 consumes <2.5 mA of quiescent current. Toxic and oxygen electrochemical sensors generate their own signals and therefore require no additional current. If a 4-20mA output is all that is required for toxic / oxygen measurements (no LCD backlight, alarms or RS-485) the OLCT 200 may be used in the 2-wire mode.

**CAUTION:** It is important to understand the receiver, or controller device must supply the loop power in 2-wire 4-20mA modes. Be sure the receiver to be used supports this type of operation.

**Instructions:**

Unscrew the cover on the OLCT 200 explosion-proof enclosure. Loosen the 2 thumbscrews holding the display assembly in place and remove it. A small sensor cable is attached with sufficient length to allow access to the back of the display assembly where 2 position TB1 is located. Route the receiver wires through the conduit entry and connect to TB1. Steering diodes in the OLCT 200 2-wire 4-20mA output automatically correct for polarity so positive and negative are interchangeable. Reassemble the OLCT 200. Follow the procedures and recommendations in the receiver manual to complete the installation. Be sure the OLCT 200 enclosure and conduit are properly grounded. Apply loop power by appropriately powering the receiver device (DCS, PLC, Controller, etc) and the OLCT 200 should function. Proceed to section-3.

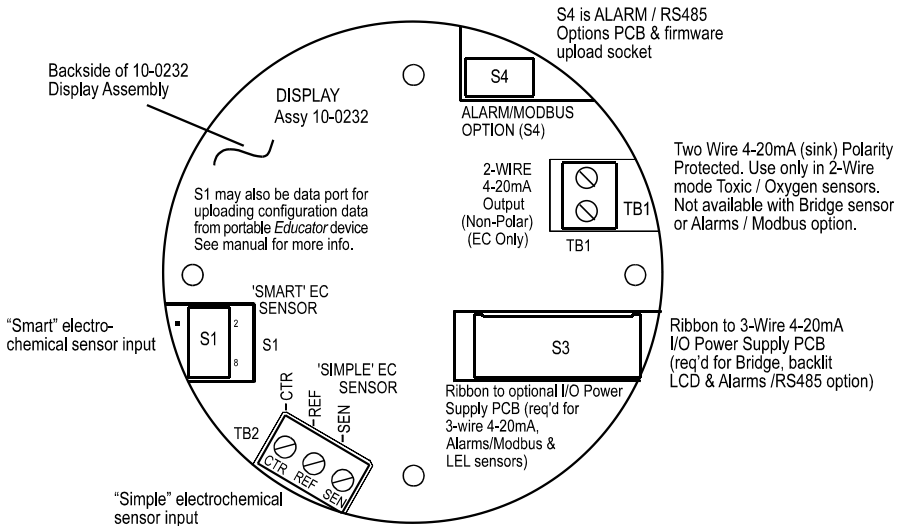

**Figure 2-4: 10-0232 Display / 2-Wire 4-20mA Assembly**

## 2.6.2 Installation Drawing # 11-0100

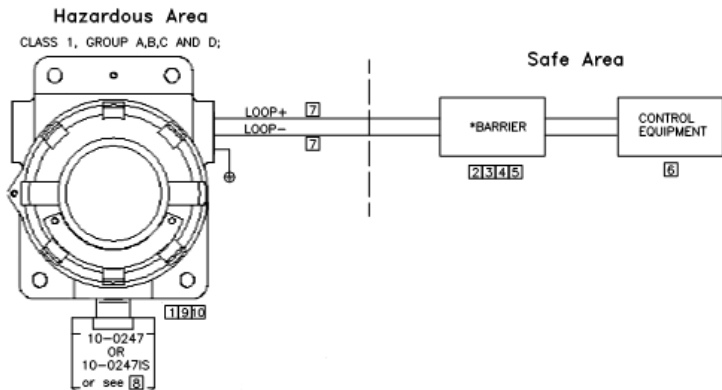
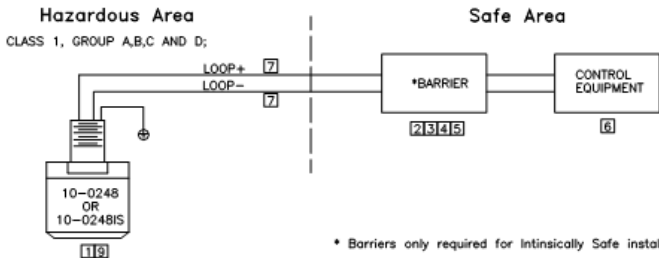

10 A conduit seal within 18 inches of the enclosure is not required for Intrinsically Safe installations.

9 Warning: Substitution of components may impair intrinsic safety.

8 The OLCT200 may be fitted with any CSA certified compatible XP toxic sensor head. The hazardous location installation is limited to an area governed by the lowest group rating of the assembly's parts.

7 Intrinsically safe wiring. Important: Only OLCT200 two wire models may be applied in intrinsically safe installations.

6 Control equipment must not use or generate more than 250 V with respect to earth.

5 Barriers must be installed in accordance with barrier manufacturer's control drawing and article of the National Electrical Code ANSI/NFPA 70, CEC Part 1 or other local installation codes, as applicable.

4 Selected barriers must be third party approved as intrinsically safe for the application and have  $V_{cc}$  not exceeding  $V_{max}$  and  $I_{sc}$  not exceeding  $I_{max}$  of the intrinsically safe equipment, as shown in Table 1.

Table 1:

I.S. Equipment	Barrier
$V_{max}$	$V_{oc}$
$I_{max}$	$I_{sc}$
$C_i + C_{cable}$	$C_a$
$L_i + L_{cable}$	$L_a$

3 Cable capacitance plus intrinsically safe equipment capacitance must be less than the marked capacitance ( $C_a$ ) shown on any barrier. The same applies for inductance. Capacitance and inductance of field wiring from the intrinsically safe equipment to the barrier should be calculated as ( $C_{cable} = 60\text{pF/ft}$  and  $L_{cable} = 0.2\ \mu\text{H/ft}$ ) and should be included in system calculations.

2 Barrier may be in Division 2 location if so approved.

1 Entity parameters:

$V_{max} = 30\ \text{Vdc}$   
 $I_{max} = 100\ \text{mA}$   
 $C_i = 0$   
 $L_i = 0$

### 2.6.3 3-Wire 4-20mA Mode Installation

**CAUTION:** OLCT 200's equipped with the 10-0233 I/O Power Supply board only operate as 3 or 4-wire 4-20mA transmitters and are not compatible with 2-wire intrinsically safe installations (see sections 2.6.1 and 2.6.2). Such units should not be combined with 10-0247IS Sensor Heads without flame arrestors unless the area is classified as non-hazardous.

OLCT 200's equipped with the 10-0233 I/O Power Supply and 10-0234 Alarms / Modbus option are NRTL certified as suitable for Div 1 & 2 Groups B,C,D explosion proof installations with the 10-0247 or with any sensor head with an equivalent CSA certification.

#### **Description:**

3-wire sourcing transmitters require an additional dedicated 24 VDC wire. The 4-20mA loop current is then delivered, or sourced, from the transmitter output and the receiver device must not provide 24 VDC from its input terminal. When the OLCT 200 is equipped with the bottom 10-0233 I/O Power Supply board shown in Figure 2-5, the 2-wire 4-20mA output is disabled and one of the 10-0233's 3-wire outputs must be used. TB2 terminal 2 is for ECHEM toxic / oxygen 3-wire 4-20mA output signals and TB2 terminal 3 is for LEL 3-wire 4-20mA output signals.

#### **Instructions:**

Unscrew the cover on the OLCT 200 explosion-proof enclosure. Loosen the 2 thumbscrews holding the display assembly in place and remove it. A small ribbon cable is attached with sufficient length to allow access to the I/O PCB mounted in the bottom of the enclosure (Figure 2-5). Power and signal connections are to TB2 where 24 VDC, Signal and Common wires must be connected. A blocking diode protects the OLCT 200 if polarity of the power supply is reversed but it will not operate.

Reassemble the OLCT 200. Follow the procedures and recommendations in the receiver and power supply manuals to complete the installation. Be sure the OLCT 200 enclosure and conduit are properly grounded. Apply power and the OLCT 200 should function. Proceed to section-3.

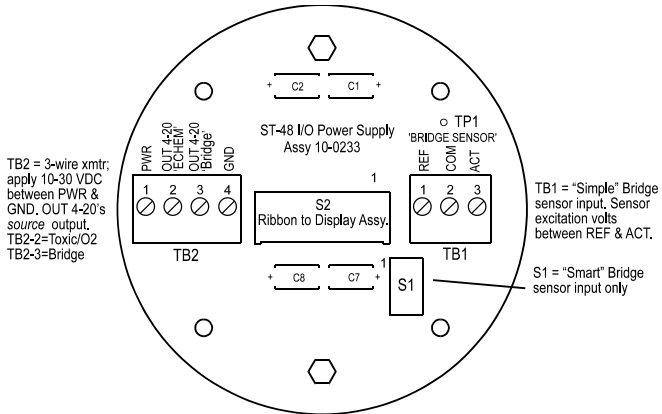
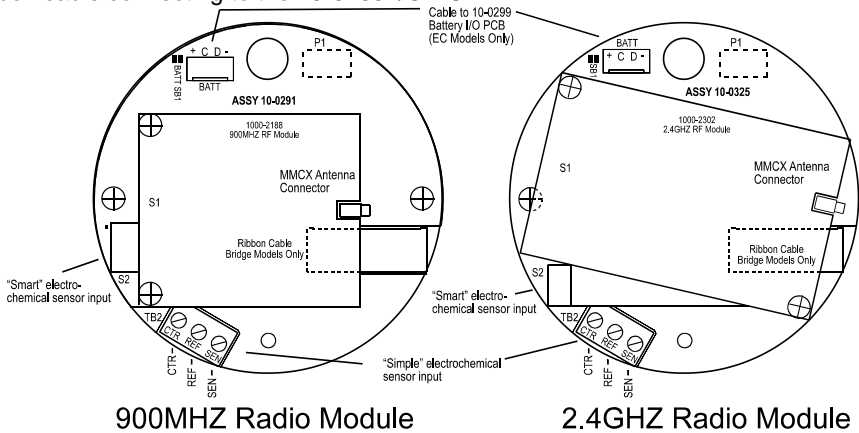

**Figure 2-5: 10-0233 I/O Power Supply / 3-Wire 4-20mA Assembly**

## 2.6.4 Wireless Model Installation

### 2.6.4.1 OLCT 200 RF Modules and Wiring

The OLCT 200's radio module mounts "piggy back" to the back of the Display assembly as shown in Figure 2-6. The module's MMCX RF connector connects to the antenna fitting's pigtail coax cable. OLCT 200 wireless 10-30VDC models have a ribbon cable connecting to the 10-0233 I/O PCB.



**Figure 2-6: 10-0291 900MHZ / 10-0325 2.4GHZ RF Modules**

OLCT 200 10-30VDC wireless Transmitters may accept electrochemical, catalytic bead, PID, or IR sensors but wiring terminates differently for each. Electrochemical sensor wiring connects to the back of the Display assembly as shown in Figure 2-6. Catalytic Bead, PID, and IR sensor wiring connects to the I/O board as shown in Figure 2-7.

For OLCT wireless 10-30VDC powered models, connect 10-30 VDC between terminals 1 & 4 of TB2 (+ wire on 1 and 0V wire on 4) as shown in Figure 2-7. Wireless models also transmit a sourcing 4-20mA output (electrochemical sensor output on TB2-2 and bridge sensor outputs on TB2-3).

**Instructions:**

Unscrew the cover on the OLCT 200 explosion-proof enclosure. Loosen the 2 thumbscrews holding the display assembly and remove it. A small ribbon cable is attached with sufficient length to allow access to the I/O PCB mounted in the bottom of the enclosure (Figure 2-7). Power and signal connections are to TB2 where 24 VDC, Signal and Common wires must be connected. A blocking diode protects the OLCT 200 if polarity of the power supply is reversed but it will not operate. Reassemble the OLCT 200. Follow the procedures and recommendations in the receiver and power supply manuals to complete the installation. Be sure the OLCT 200 enclosure and conduit are properly grounded. Apply power and the OLCT 200 should function. Proceed to section-3.

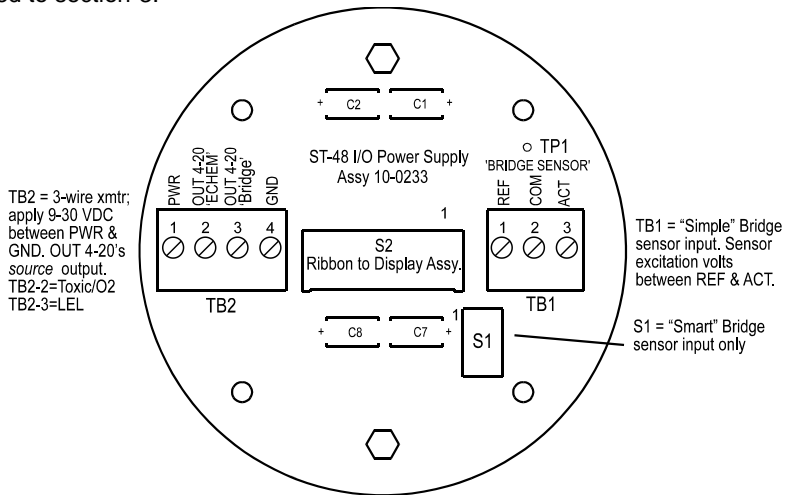

**Figure 2-7: 10-0233 I/O Power Supply / 3-Wire 4-20mA Assembly**

**2.6.4.2 Antenna Transmission Range**

The distance radio signals can travel is dependent upon several factors including antenna design, transmitter power and Freespace losses. In order for a wireless link to

work, the available system operating margin (**TX power - RX Sensitivity + Antenna gains**) must exceed the Freespace loss and all other losses in the system. For best RF line-of-site, the combined height of both antennas must exceed the Fresnel zone diameter (see below).

Dist. between ant's	Fresnel zone diameter	Freespace loss (dB)
1000 ft (300 m)	16 ft (4.9 m)	81
1 Mile (1.6 km)	32 ft (9.7 m)	96
5 miles (8 km)	68 ft (20.7 m)	110
10 miles (16 km)	95 ft (29 m)	116

Example:

The 900MHZ radio modem has the following parameters:

- Maximum RF TX power setting = 30 dBm (1 Watt)
- RF RX sensitivity = -100 dBm (this is a constant)
- Antenna gain (standard equipped dipole) = 2.1dBi x 2 = 4.2dBi

So the system operating margin is  $30 - (-100) + 4.2 = 134.2$  dBm. This is enough to transmit 10 miles if freespace was the only loss in the system. For this to be the case, the antennas must be mounted with a combined height greater than 95ft above all obstructions (including the ground) to keep the fresnel zone clear. In practice however, there are many losses in the system besides just freespace and it is recommended there be at least 20dB extra system operating margin.

RF “Rules of Thumb”

- Doubling the range with good RF “Line of Site” (LOS) requires an increase of 6 dB.
- Doubling the range without good RF LOS requires an increase of 12 dB.

### 2.6.4.3 Antenna Selection & Location

A site survey using an RF spectrum analyzer and test radios is highly recommended.

The location of the antenna is very important. Ensure the area surrounding the proposed location is clear of objects such as other antennas, trees or power lines which may affect the antenna’s performance and efficiency. It is also vital that you ensure the support structure and mounting arrangement is adequate to support the antenna under all anticipated environmental conditions. The choice of appropriate mounting hardware is also important for both minimizing corrosion and maintaining site performance.

Most installations utilize locally mounted dipole antennas as shown in Figure 2-8. An option is available for a 6 foot riser to increase the height of the antenna 6 feet above the OLCT 200. Extreme cases may require special order of directional antennas mounted in such a way to allow aiming towards the base station antenna. Minimize obstructions between the OLCT 200 and the base station antenna.

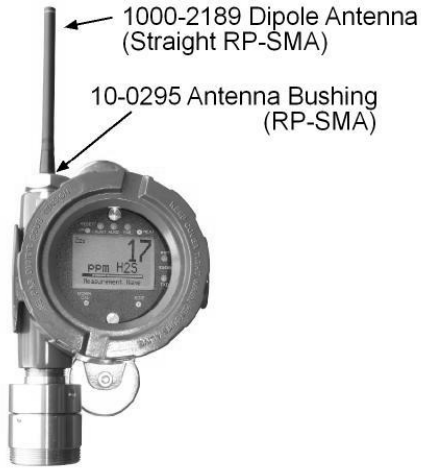

Division 2 Compliant



Division 1 Compliant

**Figure 2-8: Local Antennas (900MHZ Shown)**

#### 2.6.4.4 Water Proofing Antenna Connections

Waterproof all outdoor coax connectors using a three layer sealing process of initial layer of adhesive PVC tape, followed by a second layer of self-vulcanizing weatherproofing tape such as 3M 23 (order # 1000-2314), with a final layer of adhesive PVC tape (see Figure 2-9).

1. Attach antenna to RP-SMA fitting
2. Wrap 20-24" strip PVC electrical tape onto hub, nut & base of antenna
3. Wrap 20-24" strip 3M 23 tape (order # 1000-2314) onto PVC tape
4. Wrap 24-28" strip PVC electrical tape over all



**Figure 2-9: Water Proofing Antenna Connections**

#### 2.6.4.5 System Grounding

Direct grounding of the OLCT 200 enclosure via a good electrical connection to a well-designed grounding system is essential. This will protect your system, reduce the damage that can occur during lightning strikes and reduce noise.



## 2.7 Alarms / RS-485 Modbus 10-0234 Option Installation

### Description:

The optional 10-0234 Alarms/RS-485 Modbus board supplies two level alarm relays, a FAULT relay and an RS-485 Modbus RTU slave port (Figure 2-10). This board is “piggybacked” behind the 10-0232 Display Assembly (Figure 2-3). Addition of this option requires 3-wire mode 4-20mA operation and thereby requires the 10-0233 I/O Power Supply board (Figure 2-5). This is since relays and RS-485 circuits require much more power than 2-wire 4-20mA loops can deliver.

**CAUTION:** Alarm relays have dry contacts and power must be supplied from an external source. Contacts are rated for RESISTIVE loads! Inductive loads, such as contactor coils or motors, may cause contact arcing, which shortens life and emits RFI into the sensor signals. Use appropriate arcing snubbers and MOV’s across inductive loads and keep wiring away from signal wires. External wiring to TB3 (Remote Alarm Reset) should be shielded and protected from noise spikes to prevent false Alarm Reset.

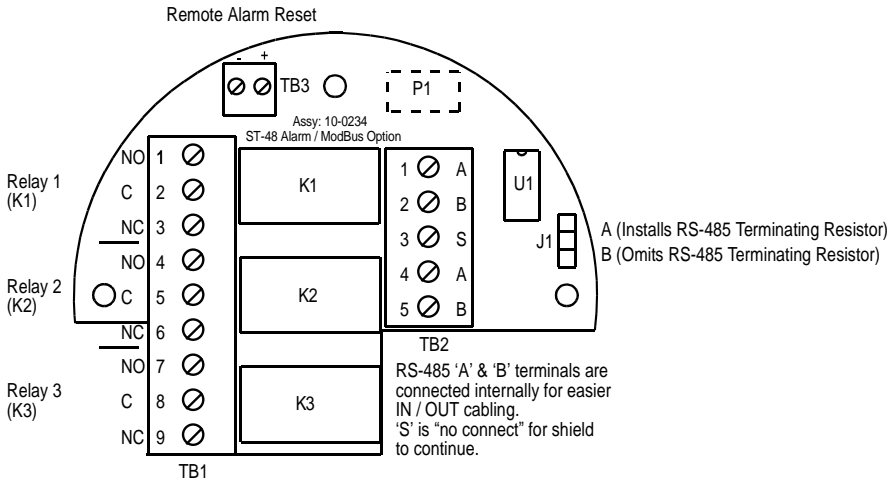
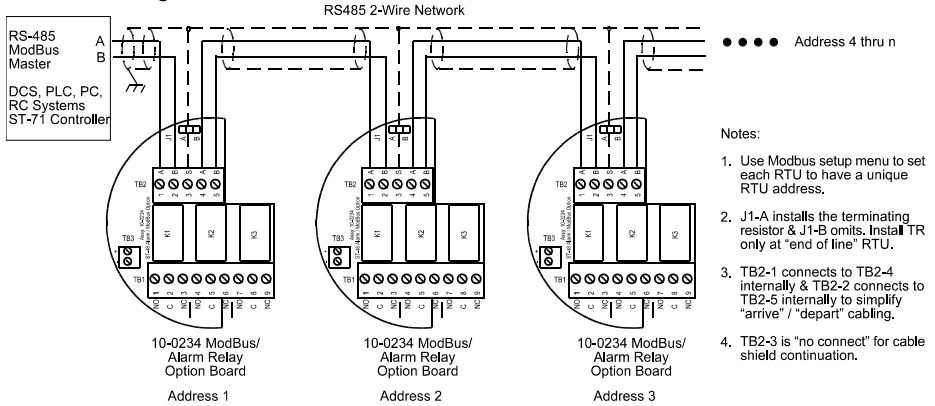

**Figure 2-10: 10-0234 Alarm Relays / Modbus Option**

### Instructions:

Unscrew the cover on the OLCT 200 explosion-proof enclosure. Loosen the two thumbscrews holding the display assembly in place and remove it. A small ribbon cable is attached with sufficient length to access the back of the Display assembly where the Alarms/RS-485 Modbus board option is located. It is possible to use only the relays, only RS-485, or use both. Relay terminals are labeled NO (normally open), NC (normally closed) and C (common or the pole). These designators correspond to the shelf, or de-energized, state of the relays. The FAULT relay is always failsafe, meaning it is energized when there is not a fault condition and therefore its action is reverse of the designators.

RS-485 Modbus networks should be wired as shown in Figure 2-11. Each OLCT 200 connected represents an RTU and must have a unique RTU address. RTU addresses are assigned in the Modbus setup menu described in section 4.10. Cabling must be a “daisy chain” as opposed to a “star” pattern for reliable operation. The “end of line” unit should have J1 installed in the ‘A’ position for terminating resistor installation. All others should have J1 in the ‘B’ position. Front panel Rx / Tx LEDs are helpful troubleshooting tools.



**Figure 2-11: RS-485 Modbus Wiring**

## 2.8 Isolated 4-20mA Output 10-0250 Option

### Description:

The optional 10-0250 Isolated 4-20mA option (Figure 2-12) provides dual 4-20mA outputs that are electrically isolated from sensor inputs and the 24 VDC power source. Each 4-20mA output share the same common terminal and are not isolated from each other. This board is “piggybacked” behind the 10-0232 Display Assembly (Figure 2-3). Addition of this option requires 4-wire mode 4-20mA operation and thereby requires the I/O Power Supply board (Figure 2-5).

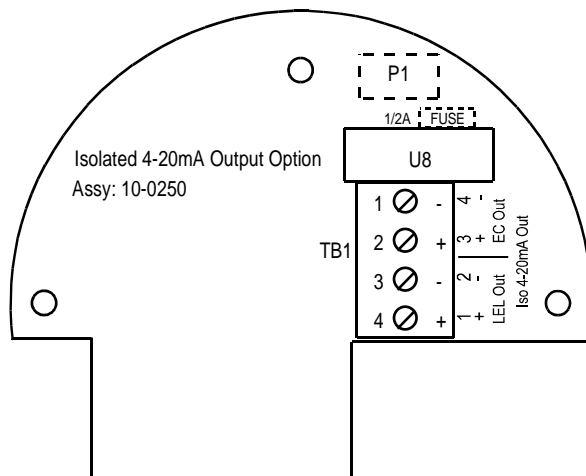

Figure 2-12: 10-0250 Isolated 4-20mA Output Option

## 2.9 HART Communication 10-0351 Option

### Description:

The optional 10-0351 HART modem board, figure 2-13, supplies ability to access and alter process variables of the OLCT 200 using a HART handheld device. This board is stacked behind the 10-0232 Display Assembly. Addition of this option requires 3-wire mode 4-20mA operation and thereby requires the 10-0233 I/O Power Supply board. This is since the modem's driver circuits require much more power than 2-wire 4-20mA loops can deliver. When installed in an OLCT 200 transmitter, power and common are run to the I/O board and TB1 supplies 4-20 mA output. Common on the HART modem and the I/O board are tied together.

In most applications the power is supplied from the controller that is receiving the 4-20 mA output. In these applications only three wires are required since common is shared from the I/O board to the HART modem through the ribbon cable. Power is connected to the I/O board and the signal connected to TB1 on the HART board.

If the 4-20 mA output is going to another device other than the one that is powering it, or the transmitter has its own local power supply, both + and – on at TB1 on the HART board must be utilized for the 4-20 mA loop to function.

### IMPORTANT

The 4-20 mA output must be loaded with at least 250 ohms of impedance for the HART modem to transmit process variables. Some devices receiving the 4-20 mA output have a large enough terminating resistor installed from the factory, but others may need additional resistance added. This is accomplished by adding a resistor in

series with the output from HART modem board, preferably at the controller end of the current loop. Adding the additional resistor at the controller allows the HART handheld to be connected anywhere in the loop, because it must have the full 250 ohm load after its connection point to function properly. If the additional resistor is added at the transmitter, in TB1, the HART handheld will only be able to access variables locally, at the transmitter. The example in 2-15 shows a 100 ohm resistor added to the output loop since the controller has a 150 ohm terminating resistor installed from the factory.

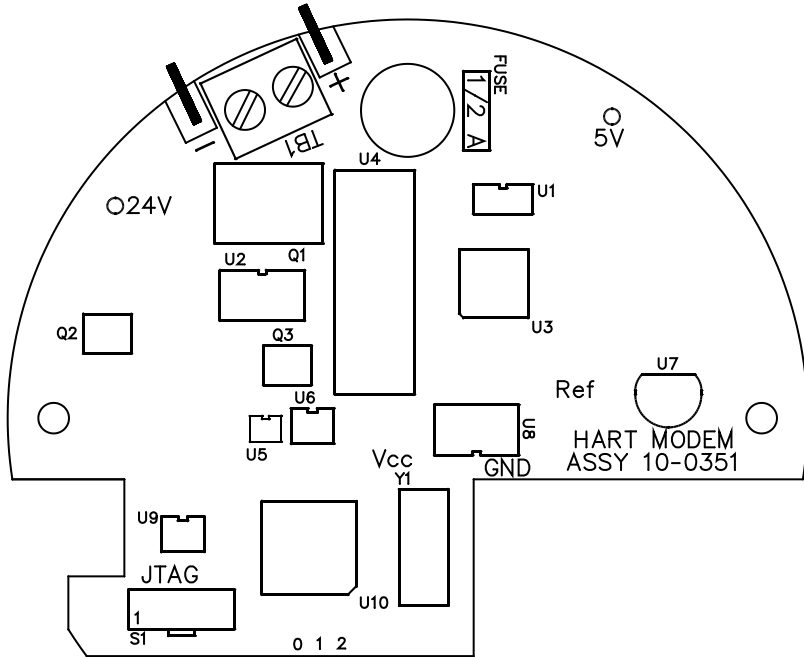

**Figure 2-13: 10-0351 HART Modem Option**

***Instructions for Accessing Process Variables with HART Handheld Device***

The HART handheld can access process variables from anywhere in the 4-20 mA loop as long as the handheld device is on the modem side of the 250 ohm load. Process variables are accessed by attaching the leads to the signal (+) and common (-) wire. Typically the process variables are accessed either at the transmitter or at the controller.

At the transmitter end of the 4-20 mA loop unscrew the cover on the OLCRT 200 explosion-proof enclosure. Find the two HART connection points located next to TB1

on the HART board and connect the leads from the Hart handheld. They can be accessed without pulling the nest assembly out of the enclosure and are on the top right side, just above the next button (See Figure 2.14).

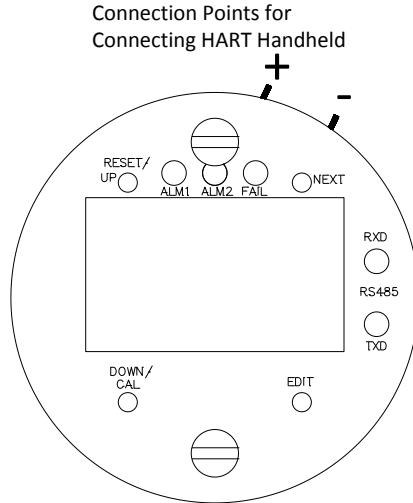

**Figure 2-14: Top View of OLCT 200 showing HART connection terminals**

At the controller end, connect the HART handheld directly across the signal and common wires coming from the HART modem. In applications that utilize WX series controllers, the terminals are labeled HI and LO with HI being the signal and LO being common.

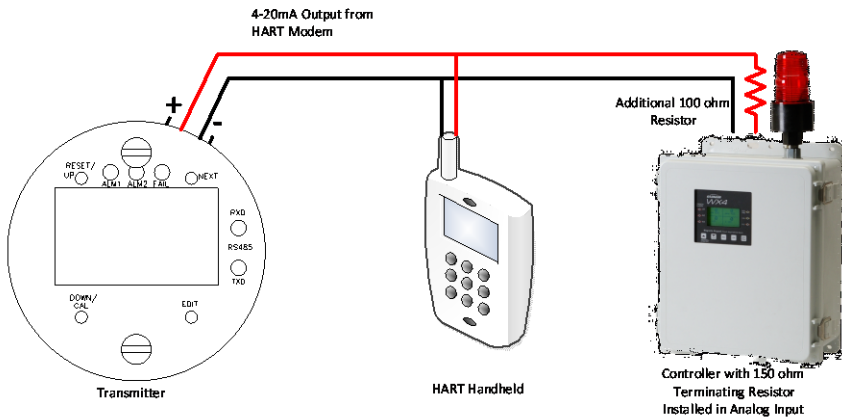
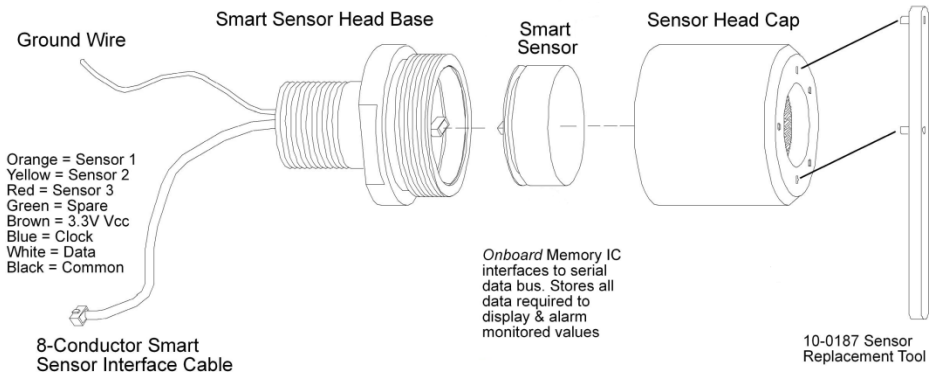

**Figure 2-15: Example of OLCT 200 HART Wiring**

## 2.10 Sensor Installation

The OLCT 200 *Smart Sensor* interface uses proven sensor technology but has taken this technology a step further. A tiny memory IC is incorporated into OLCT 200 factory supplied Smart sensors allowing them to contain the entire database of OLCT 200 parameters onboard the replaceable Smart Sensor assembly (Figure 2-16). Smart sensors plug into the 10-0247 **Smart Sensor Head** that connects to OLCT 200 electronics with its 8-conductor Smart Sensor Interface cable (Figure 2-16).

**CAUTION:** 10-0247 Smart sensor heads with electrochemical toxic / oxygen sensors must connect to S1 located on the back of the 10-0232 Display Assembly (Figure 2-3). 10-0247 Smart sensor heads with catalytic bead, Infrared, or PID sensors must connect to S1 located on the optional I/O PCB assembly (Figure 2-5).



**Figure 2-16: 10-0247 Smart Sensor Head Assembly**

Smart Sensors are automatically recognized by the OLCT 200. The Smart Sensor identification screen in Figure 2-17 is shown after power-up, upon installation of a new smart sensor or by viewing INPUT type in the SENSOR SETTINGS / INFO menu (section 5-5).

```

SMART SENSOR
Type:          Cat - Bead
Span:          100
Zero:          0
SN:            xxxxxx
Born On:      01/28/04
Last Cal:     04/05/04
ANY key to Exit
    
```

```

ERROR CODE 01
Incorrect Sensor
installed. Install
correct sensor or
update transmitter.
SEE MANUAL
EDIT key to update.
Any other to abort.
    
```

If installed sensor type does not match transmitter database

**Figure 2-17: Smart Sensor Info / ERROR Screens**

## 2.11 “Sensor Type” and OLCT 200 Signal Conditioning

Catalytic bead and electrochemical sensors obviously have different signal conditioning requirements. In addition, same sensor types have different response coefficients, signal strength and gain and offset requirements. The block / wiring diagram in Figure 2-18 illustrates how OLCT 200’s are able to accept many sensor types without the need of manual potentiometers or jumpers. Smart Sensors carry this setup information with each sensor.

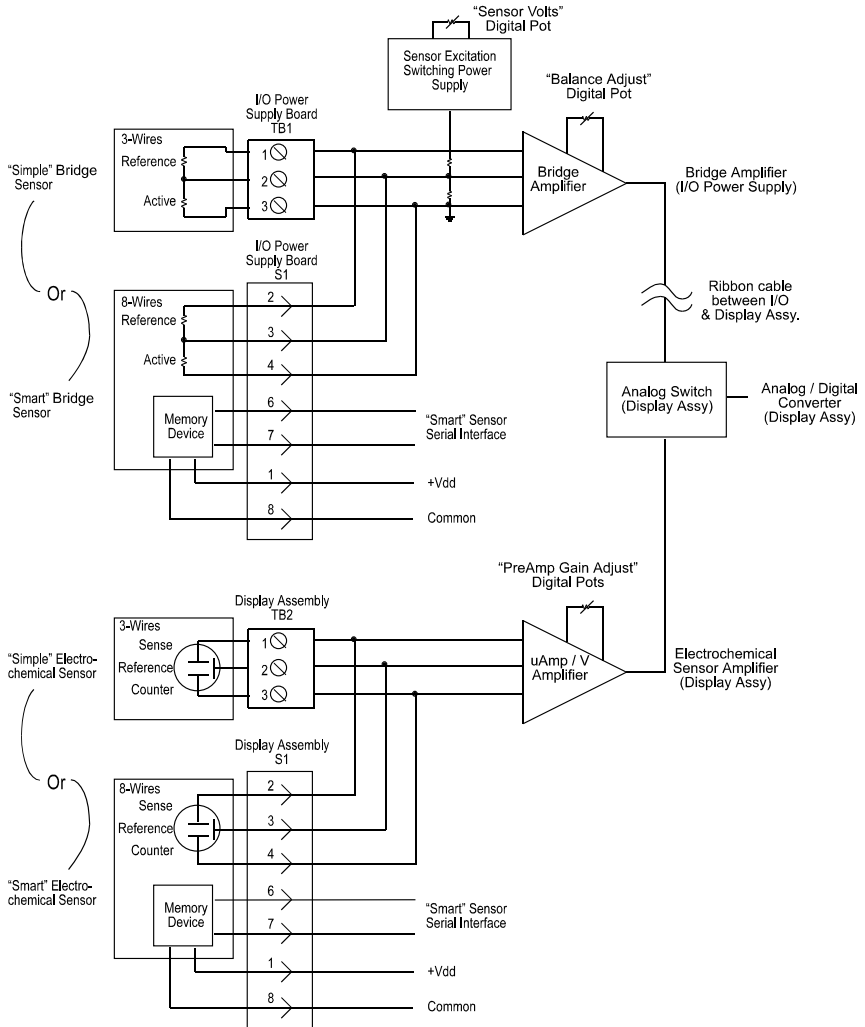

Figure 2-18: OLCT 200 Block / Wiring Diagram





# SECTION 3 - INITIAL START-UP

## 3.1 “Transmitter Configuration” Menu

Figure 3-1 shows the OLCT 200 XMITTER CONFIG menu used to activate channels, precisely calibrate 4-20mA outputs and set time / date. Its menus are set at the factory and typically not needed by the user. To access from any data display, press and hold the NEXT key for 5-seconds until the screen appears requesting a special key sequence (4-UP keystrokes). Note that not all menu options will be displays for certain models and configurations.



Figure 3-1: Transmitter Configuration Menu

### 3.1.1 Single / Dual Gas Monitor Configuration

2-wire 4-20mA and wireless OLCT 200's devices support only one electrochemical sensor. Addition of the 10-0233 Power Supply board automatically adds the catalytic bead, IR, and PID sensor input. With the addition of the 10-0233 Power Supply Board, 3-wire models have dual 4-20mA output capability. If both the O2/TOXIC and LEL/Current menu items are ON, the OLCT 200 will function as a dual gas monitor with both sensor inputs and 4-20mA outputs active. Either input may be turned off for single gas EC or LEL monitors.

### 3.1.2 Output Zero / Output Span Trims (Wired Models Only) (Factory Preset, Technicians only!):

The **Output Zero Trim / Output Span Trim** entries are digital to analog (D2A) values that determine the OLCT 200's final 4-20mA output. Their purpose is to provide precise OLCT 200 4mA and 20mA outputs. To trim these values, attach a precision milliamp meter to the OLCT 200 4-20mA output being used. Enter the correct OUTPUT ZERO TRIM menu shown in Figure 3-2. Use the UP/DOWN keys to trim the milliamp value to 4.00mA. Next, enter the correct OUTPUT SPAN TRIM menu and use the UP/DOWN keys to trim the milliamp value to 20.00mA. Press the NEXT key to exit this menu. The OLCT 200 stores these new D2A values and uses them as the 0 & 100% of full-scale endpoints.

**WARNING:** Target gas monitoring and alarm processing are halted during these adjustments.

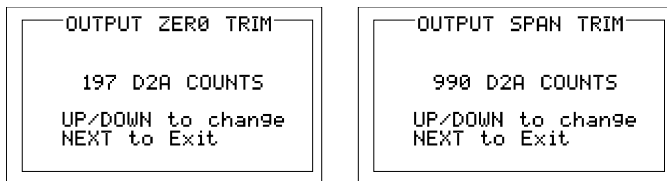

Figure 3-2: Output ZERO / SPAN Trim Menus

### 3.1.3 Model Name

When power is applied to the OLCT 200 it will briefly show a 10 digit ASCII model name or company name as it starts up. The name can be edited in the Transmitter Configuration menu by editing the **Model** field.

## 3.2 Initial Bridge Sensor Monitor Start-Up

OLCT 200 LEL Monitors that are factory equipped with Smart Bridge sensors rarely require adjustments, other than routine calibrations, to provide accurate LEL readings. However, after installation the following checks should be performed to insure proper operation. In addition, alarm levels, Measurement Name ASCII fields and other variables may require configuration by users in order to best serve their application.

### 3.2.1 Initial Bridge Sensor Monitor “Sensor Volts” Check

**CAUTION: Sensor Volts** in excess of the rated values may destroy catalytic bead sensors. OLCT 200 sensors are rated for 2 volts.

Section 6.2 describes reading and setting “sensor volts” using the OLCT 200 LCD. The voltage displayed on the LCD is monitored across TB1-REF and TB1-ACT on the OLCT 200 Power Supply board (Figure 2.4) and may be confirmed with a voltmeter. This TB-1 value is correct for locally mounted sensors only. Sensors mounted more than a few feet away from the OLCT 200 may receive a lower voltage due to the inherent voltage drop across sensor wiring. Remote mounted sensors must have their sensor voltage (across ACTIVE and REFERENCE beads) measured AT THE SENSOR end of the cable. The OLCT 200 setting will require a higher value in order to achieve the correct voltage at the sensor. Correct sensor voltage should be confirmed after start-up for locally and remotely mounted catalytic bead sensors.

### 3.2.2 Initial Bridge Sensor Monitor “Balance” Check

Catalytic bead sensors connect to a bridge circuit that may require a balance adjustment after installation especially when the sensor is remote mounted from the OLCT 200. Section 7.2 describes using the LCD to read and adjust BALANCE settings. Correct BALANCE setting should be confirmed after start-up for locally and remotely mounted catalytic bead sensors.

### 3.2.3 Initial Bridge Sensor Monitor “Span” Check

Prior to the initial *Routine Sensor Calibration* described in section 4.1, a coarse SPAN gas reading verification should be performed after installation. After correct Sensor Volts and BALANCE have been verified, apply an upscale gas value such as 50% LEL to the sensor. The indicated value should read between 35 and 65% LEL with 50% LEL gas applied. Larger errors may indicate incorrect sensor wiring or defective sensor. Remember that this is only a coarse check and precision calibrations are performed in *Routine Sensor Calibrations* described in the following section 4.1. Section 7.4 describes PREAMP GAIN adjustments that may be required if full-scale ranges are changed.

## 3.3 Initial Toxic / Oxygen Sensor Monitor Start-Up

OLCT 200 Toxic / Oxygen Monitors, factory equipped with Smart electrochemical sensors, rarely require adjustments (other than routine calibrations) to provide accurate readings. However, after installation the following checks should be performed to insure proper operation. In addition, alarm levels, Measurement Name ASCII fields and other variables may require attention by users in order to best serve their application.

### 3.3.1 Initial Toxic / Oxygen Sensor Monitor “Span” Check

Prior to the initial *Routine Sensor Calibration* described in section 4.1, a coarse SPAN gas reading verification should be performed after installation. Apply an upscale gas value of at least 25% of full scale to the sensor. For example, if 0-100ppm H<sub>2</sub>S is the measurement range, apply at least 25ppm but not more than 100ppm. The indicated value should read within 15% of full scale. Remember that this is only a coarse check and precision calibrations are performed in *Routine Sensor Calibrations* described in the following section 4.1. Section 6.4 describes PREAMP GAIN adjustments that may be required if full-scale ranges are changed.



# SECTION 4 - OPERATING INSTRUCTIONS

## 4.1 Routine Sensor Calibrations

Calibration is the most important function for insuring correct operation of the OLCT 200. The CAL MODE (flow chart shown in Figure 4-2) is designed to make calibration quick, easy and error free. A successful ZERO and SPAN calibration requires only four keystrokes. The 4-20mA output indicates CAL MODE by transmitting 3mA for 2-wire installations and 1.5mA for 3-wire installations. The OLCT wireless model's 10-bit output transmit 200-1000 counts for 0-100% full scale. It indicated cal mode by transmitting 75 counts (-15.6% FS) to receivers on the network. After the calibration is complete, 2/3 wire models transmit 4mA during the subsequent CAL PURGE delay to prevent external alarms during calibration. Wireless models transmit 200 counts (884 counts for oxygen) during CAL PURGE. Local OLCT 200 alarm relays (if equipped) are inhibited during CAL MODE. CAL MODE automatically exits if no keystrokes are detected after 5 minutes.

Follow these OLCT 200 calibration guidelines:

- Calibration accuracy is only as good as the calibration gas accuracy. Oldham recommends calibration gases with NIST (National Institute of Standards and Technology) traceable accuracy to increase the validity of the calibration.
- Do not use a gas cylinder beyond its expiration date.
- Calibrate a new sensor before use.
- Allow the sensor to stabilize before starting calibration (approximately 5 minutes).
- Calibrate on a regular schedule. (Oldham recommends once every 3 months, depending on use and sensor exposure to poisons and contaminants.)
- Calibrate only in a clean atmosphere, which is free of background gas.

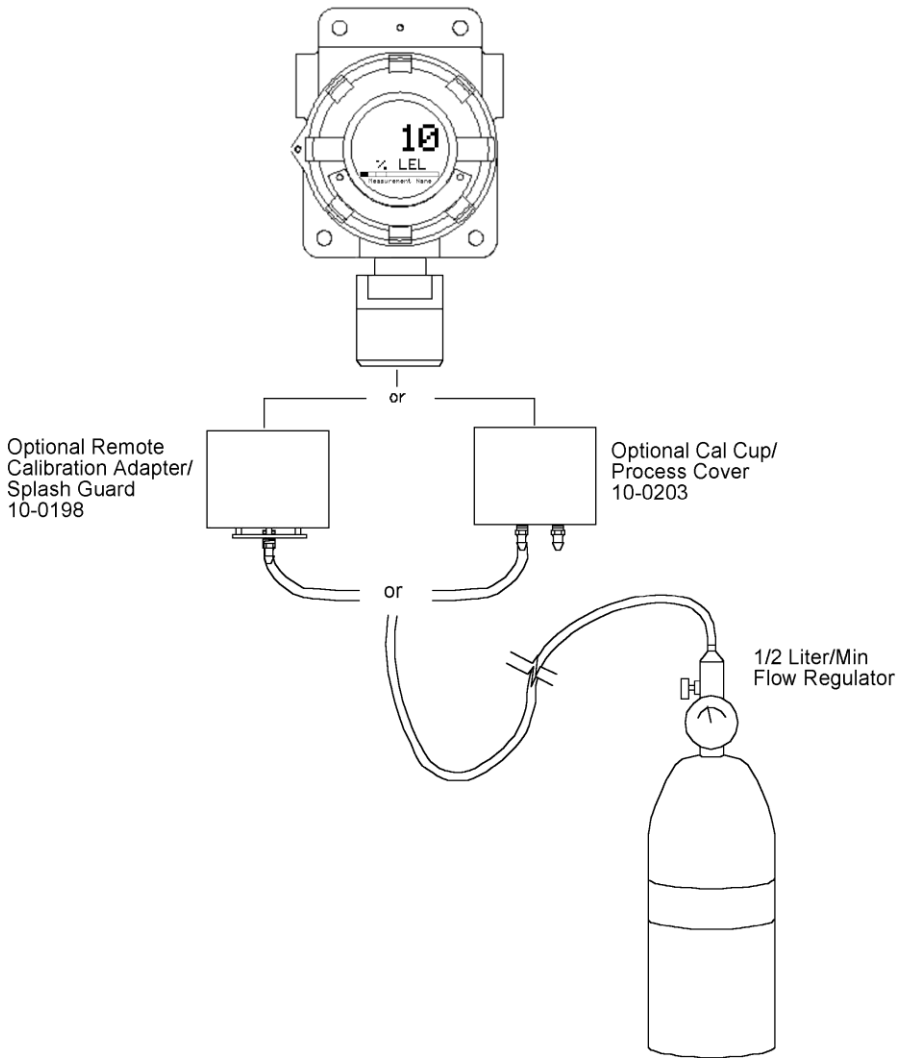

**Figure 4-1: Calibration Gas Input**

Use the following step-by-step procedure to perform ZERO and SPAN calibrations.

1. To enter the CAL MODE from either data display, press the DOWN / CAL key and within 5 seconds press the EDIT key. **Note:** During CAL MODE, the follow signal is transmitted to the receiving device and signifies "CAL MODE". This special value is used to inhibit alarm trips at the receiver.

2 Wire Model	3 Wire Model	10-30VDC Wireless Model	Battery Powered Wireless Model
3mA	1.5mA	75 counts (-15.6%FS)	75 counts (-15.6%FS)

**FOR OXYGEN (O2), SKIP STEPS 2 & 3 AND PROCEED DIRECTLY TO THE SPAN CALIBRATION BY PRESSING THE "NEXT" KEY.**

2. Using the Cal-Cup, apply a clean ZERO gas or be sure there is no background target gas in the monitored area. After the reading is stable, (approximately 1 minute) press the EDIT key to perform a ZERO calibration.
3. If the ZERO calibration is successful, press the NEXT key to proceed to the SPAN check.
4. Apply the **correct** SPAN gas at .5 liters/min. After the reading is stable, (approximately 1 minute) press the EDIT key to perform a SPAN calibration. **WARNING:** The SPAN gas used must match the value specified since this is what the OLCT 200 will indicate after a successful SPAN calibration. The **Cal Span Value** may be edited if it becomes necessary to apply a different gas concentration (see **Cal Span Value** in section 5.3).
5. If the SPAN calibration is successful, the display flashes "REMOVE CAL GAS" and starts the CAL PURGE delay. **Note:** During CAL PURGE delay, transmitters are set to 0% full scale to avoid unintended alarm events. Oxygen monitors are set to 20.9% oxygen during this delay.
6. CAL MODE will be complete after the end of the CAL PURGE delay.

The flow chart in Figure 4-2 illustrates the above procedure. UP, CAL, NEXT & EDIT labels indicate keystrokes using the magnetic wand. The CAL MODE information screen (top of the chart) is available for advanced users to see Offset / Gain calibration constants and live analog to digital converter (A/D) counts. Span Gas calibration values may also be edited from this screen. Holding the UP key, for 5 seconds during CAL MODE, displays this screen.

Calibration history records are logged and may be viewed in the *Sensor Information* menu (see section 5-5).

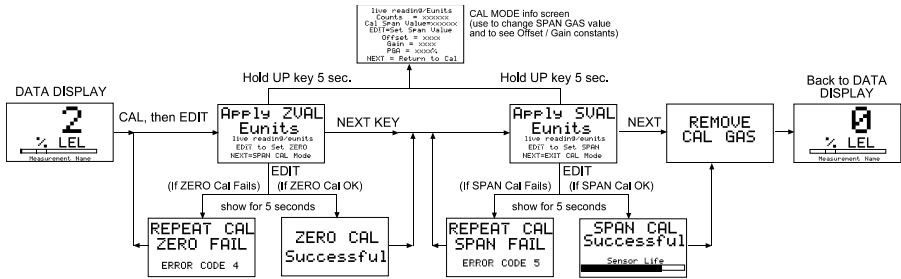

Figure 4-2: Cal-Mode Flow Chart and Menus

## 4.2 ALARM OPERATION

OLCT 200's have front panel LED indicators for Alarm 1, Alarm 2 and Alarm 3. An optional 10-0234 Relay/Modbus board adds K1, K2 & K3 relays for these alarms.

**CAUTION:** OLCT 200 Alarm LED indicators function even without the presence of the 10-0234 Relay option. With 2-Wire 4-20mA and wireless operation, to conserve power, alarm LED's only flash during alarm events. With 3-Wire 4-20mA operation, alarm LED's flash when new, and become steady after an operator ACKNOWLEDGE - pressing the UP/RESET key.

For OLCT 200 wireless models, "Low Battery" is indicated by an icon on the LCD and by flashing the FAIL LED. ALL ALARM EVENTS EXCEPT FOR LOW BATTERY INCREASE WIRELESS TRANSMISSIONS TO EVERY 6 SECONDS.

### 4.2.1 ALARM 3 – UNDERSTANDING FAULT / LEVEL OPERATION

The "A3" alarm is typically dedicated to FAULT conditions indicating sensor failures or "out of measurement range" conditions. However, some applications require a third level alarm. The A3 menu is identical to A1 & A2 and may be set to trip at an upscale level value. A3 WILL ALSO TRIP WITH MISSING OR FAILED SENSORS REGARDLESS OF THE LEVEL VALUE!

**CAUTION:** Missing or failed sensors always trip Alarm 3 (FAIL) and relay K3 (if equipped). This is true even with A3 configured as a level alarm and it must be accepted that A3 level alarm events might be caused by the monitored level, or, by a missing or failed sensor. A3 and FAIL alarm conditions DO NOT cause the radio transmission rate to increase to 6 seconds.



# SECTION 5 - SETUP MENU CONFIGURATION

## 5.1 Menus Database Configuration

All OLCT 200 configuration variables are stored in its non-volatile menu database. Upon installation, many menu items will contain default values from the factory and require changes to better match a user's particular application. OLCT 200 menus may be configured from the magnetic keypad in just a few minutes per transmitter. The OLCT 200's configuration menus are shown in Figure 5-1.

Pressing EDIT from either data display enters the LEL or EC SETUP PAGE 1 menu.

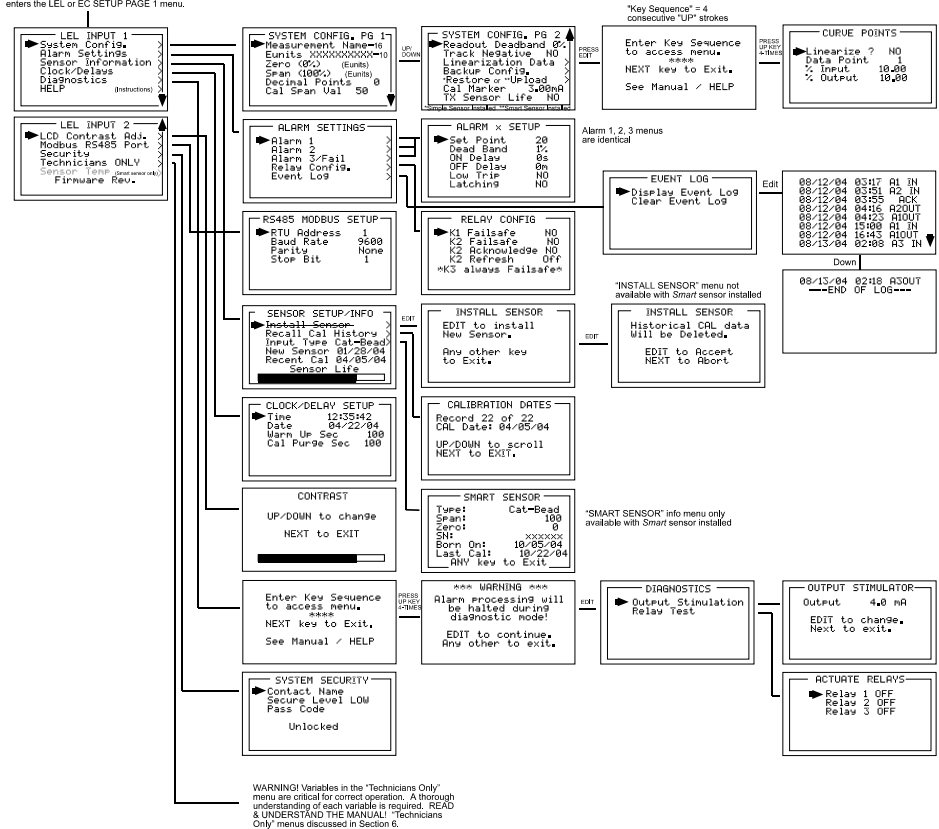

Figure 5-1a: Configuration Menu Tree - Wired Models

Pressing EDIT from either data display enters the EC SETUP PAGE 1 menu.

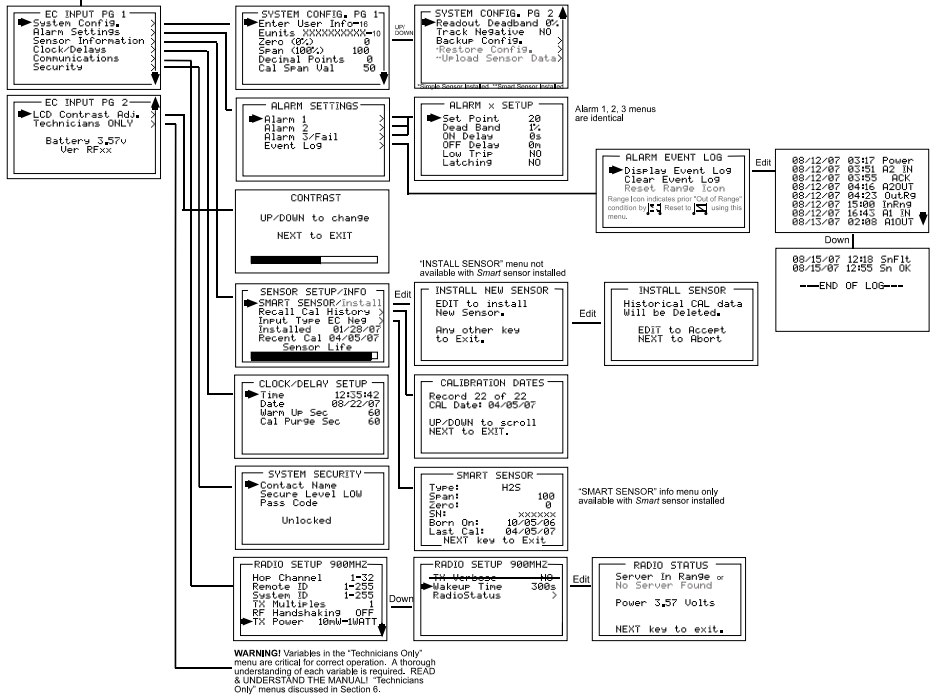
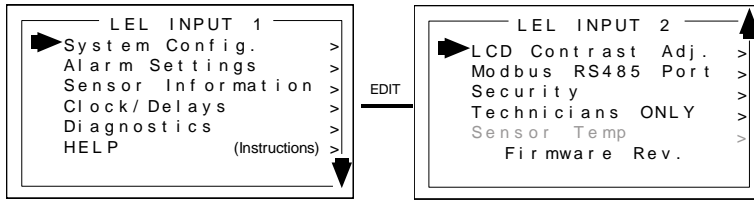

Figure 5-1b: Configuration Menu Tree- Wireless Models

## 5.2 Configuration Using the Magnetic Wand

Passing the magnetic wand past the EDIT key, from either data display, displays SETUP PAGE 1 as shown in Figure 5-2. The UP / DOWN keys maneuver the pointer while EDIT enters sub-levels of menu items. All SETUP menu items have at least one page of sub-menus. Items with sub-menus are indicated by the > symbol (right hand pointing arrow) at the end of each line. Edit menu items by pointing to them, press the EDIT key to display the cursor, press UP / DOWN to change that character, press NEXT to move the cursor, then press EDIT again to load the new item and remove the cursor. Press NEXT to reverse out of the sub-menu. To view **SETUP PAGE 2**, press the DOWN key with the pointer aimed at the bottom item on PAGE 1.



“Sensor Temp” menu only present with “Arctic” smart sensor installed. See section 7.1.

Figure 5-2a: Setup Menu Entry – Wired Models

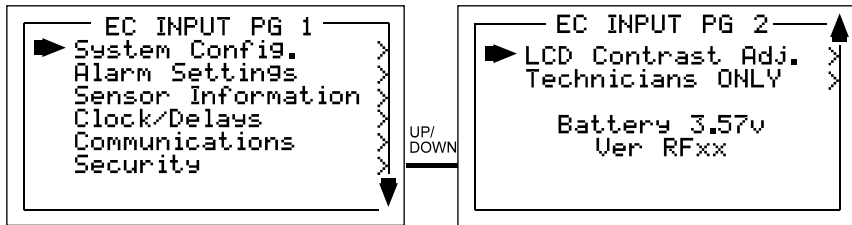

Figure 5-2b: Setup Menu Entry – Wireless Models

### 5.3 System Configuration Menus

The **System Config.** group consists of two pages of menus as shown in Figure 5-3. Each item’s description follows in this section.

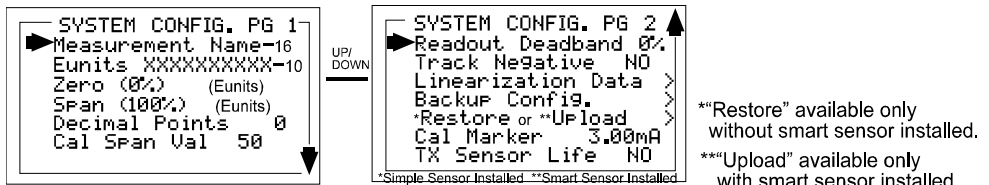

Figure 5-3: System Config. Menus

**Measurement Name** may be edited to contain virtually any 16-character ASCII field. It is typically used to describe the monitored point by user tag # or other familiar terminology.

**Eunits** (engineering units) may have up to a 10 character ASCII field. Many common gases have pre-configured Eunits based upon the sensor type and each may be edited in this menu as described in *Configuration Using the Magnetic Wand* section 5-2.

**Zero (0%)** defines the reading to be displayed when 4mA (0%) is the OLCT 200 output.

**Span (100%)** defines the reading to be displayed when 20mA (100%) is the OLCT 200 output. The highest reading allowed is 9999 includes negative polarity sign and one decimal point. Polarity is only indicated for negative readings.

**Decimal Points** sets the resolution of the LCD readings and may be for 0, 1 or 2. Example: ZERO readings for 0, 1 & 2 DP's respectively are 0, 0.0 & 0.00.

**Cal Span Value** sets what upscale value must be applied when performing Span calibrations.

**Readout Deadband** allows forcing low values to continue to read zero. This is useful when there are small amounts of background gases that cause fluctuating readouts above zero. The highest amount of deadband allowed is 5%. The 4-20mA output is not affected by this menu item.

**Track Negative**, set to NO, causes negative values to read the **Zero (0%)** value in data displays. The CAL MODE readout displays negative values regardless of this setting and negative values below the Fault set point will still cause the Fault alarm to trip. The 4-20mA output always locks at 4mA when the reading is negative.

**Linearization Data** allows nonlinear signals to be linearized by entering the correct curve into the OLCT 200 (Figure 5-4). If Linearize is set for NO, the CURVE POINTS menu data is not used and no linearization is applied. When YES, the CURVE POINT entries are used and a straight-line approximation is calculated between each of the 9 entries. 0% input always provides 0% output and 100% input always provides 100% output. To prevent accidental data entry a special keystroke sequence, of 4 consecutive UP keys, is required to enter this menu.

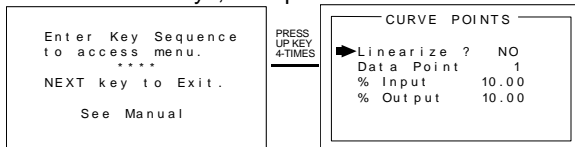

Figure 5-4: Linearization Menu

**Backup Config.** allows users to store the entire current OLCT 200 menu database into non-volatile memory for restoration later if incorrect values are accidentally entered or uploaded.

**Restore Config.** restores the OLCT 200 menu database to the values from the most recent Backup Config. This menu item is only available if a smart sensor is not installed. The special keystroke sequence of 4 consecutive UP keys is also required to perform backup and restore operations.

**Upload Sensor Data** allows manually uploading the entire smart sensor database to the OLCT 200 from the smart sensor.

**Cal Marker (wired models only)** allows setting the 4-20mA output value during ZERO and SPAN calibrations at a level to prevent alarm trips by calibration values. 3-Wire models may be set from 0 to 20mA. Quiescent current of 2-wire models limits this setting to 3 to 20mA.

**TX Sensor Life (wired models only)** set for YES, causes the OLCT 200 4-20mA output to transmit a sensor life value after successful calibrations during the CAL PURGE delay (see section 4.1). Normal operation is the OLCT 200 transmits 4mA during the CAL PURGE delay. But with **TX Sensor Life = YES** it transmits 4mA for the first 10-seconds, then for 5-seconds transmits a value between 4mA and 5mA, with 4mA equal to 0% sensor life and 5mA equal to 100% sensor life (see Figure 5-5). The output then returns to 4mA for the remainder of the CAL PURGE delay. For example, if after a calibration sensor life is 75%, the OLCT 200 transmits 4.75mA during the 5-second interval.

Note: **TX Sensor Life** should always be set for NO unless the 4-20mA receiver is capable of interpreting the sensor life signal. The Oldham WX16 Controller is capable of this function.

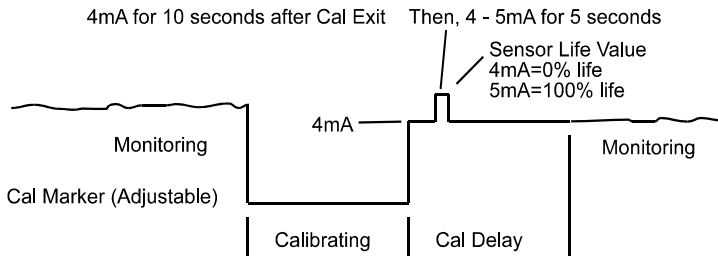

**Figure 5-5: Transmit Sensor Life Timing Diagram**

## 5.4 Alarm Settings

The **Alarm Settings** page has the **Alarm 1, 2, 3 Setups, Relays** and **Event Log** submenus shown in Figure 5-6. Alarm 1, Alarm 2 and Alarm 3/Fail menus are identical and therefore described only once in this section.

**IMPORTANT:** Alarm functions and their associated LED's are active without the 10-0234 Relay / Modbus option installed. Alarm conditions are indicated by A1, A2, A3 LCD icons and by flashing the A1, A2 and FAIL led's. The **Event Log** time and date stamps significant events such as power applied, alarm trips sensor faults and wireless INRange / Out of Range conditions. The wireless range icon changes to  after an Out of Range and subsequent return to InRange event. It may be reset to normal with the **Reset Range Icon** menu.

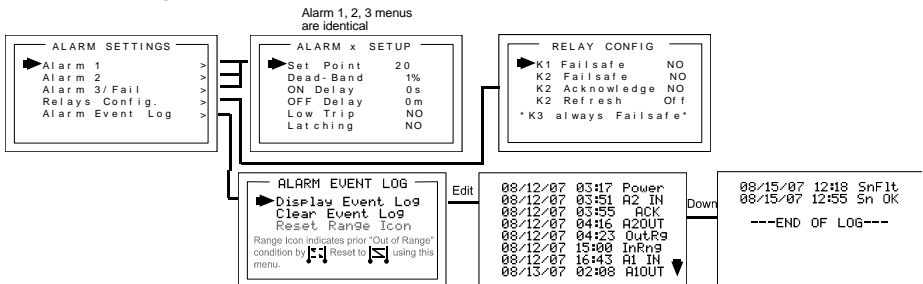

Figure 5-6: Alarm Settings Menus

**Set Point** enters the engineering unit value where the alarm trips. It may be negative and trip when monitored values fall out of range in this direction. A3 has a default negative 5% of range Set Point with Low Trip set for YES. This makes it function as a FAULT alarm and trip when the monitored value is more than 5% “out of range”.

**Dead-Band** has a minimum value of 1% and a maximum value of 10%. It is useful for preventing alarm cycling when the monitored value is hovering around the set point. **EXAMPLE:** With a range of 0-100 ppm, if Dead-Band equals 5% and the set point is 20 ppm, after tripping at 20 ppm the value must drop below 15 ppm to reset.

**ON Delay** allows entering a maximum 10 second delay before this alarm becomes active. This is useful for preventing nuisance alarms caused by brief spikes beyond the set point.

**OFF Delay** allows entering a maximum 120 minute delay before clearing an alarm after the alarm condition is gone. This is useful for continuing an alarm function, such as operation of an exhaust fan, for a period of time after the alarm condition clears.

**Low Trip** set to YES causes the alarm to trip as the value falls below the set point.

**Latching** set to YES causes the alarm to remain active even after the condition is gone and only reset when the UP / RESET key is pressed from a data display.

#### 5.4.1 Relay Configuration (if equipped)

**Relay Config** has the submenu shown in Figure 5-7. The optional relay PCB must be installed to access this menu or a “HARDWARE NOT PRESENT” message appears.

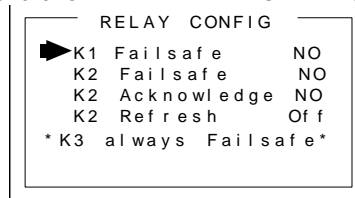

**Figure 5-7: Relay Config. Menu**

**K1 / K2 Failsafe** set for YES means the relay de-energizes during alarm and energizes with no alarm. This is useful for also signaling alarm when OLCT 200 power is lost. K3 is a FAULT alarm and is always failsafe.

**K2 Acknowledge** set for YES means the UP / RESET key (RESET key during either data display) will set K2 to the normal state EVEN when an Alarm 2 condition exists. This is useful for silencing an audible device, driven from K2, during the alarm condition.

**K2 Refresh** set for ON causes an acknowledged Alarm 2 condition to reactivate K2 if it continues beyond the designated Refresh interval (0-99 minutes). This feature insures against “forgotten” alarms after an Acknowledge.

## 5.5 Sensor Information

**Sensor Information** has the **SENSOR SETUP/INFO** menus shown in Figure 5-8

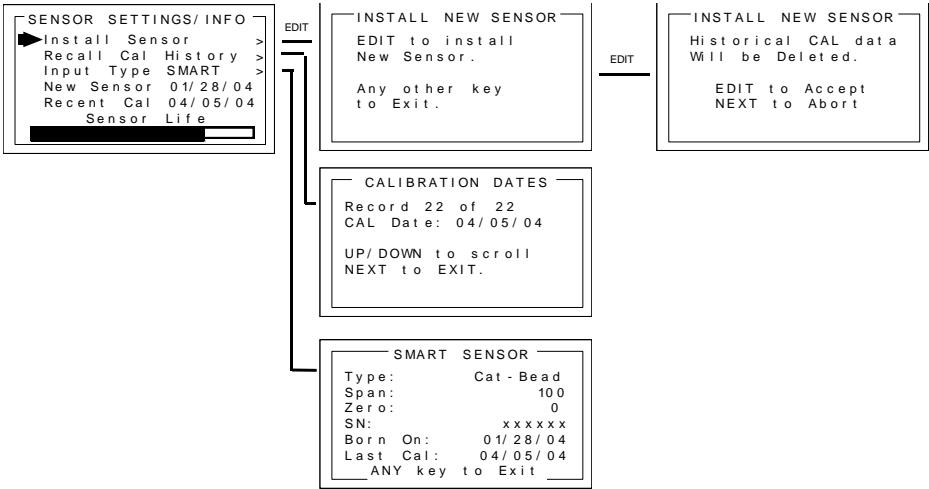

**Figure 5-8: Sensor Information Menus**

**Install New Sensor** - The OLCT 200 *Smart* sensor interface will automatically detect new smart sensors and this menu is therefore not available with a smart sensor connected.

**Recall Cal History** recalls each successful calibration. These dates may be reviewed by scrolling with the UP / DOWN keys.

**Input Type** indicates what kind of input or sensor the OLCT 200 is configured to accept and is typically pre-configured at the factory. There are five Input Type possibilities consisting of bridge, EC negative, EC positive, 4-20mA and Smart. Smart sensors upload sensor type and other data to the OLCT 200 and may be viewed on the SMART SENSOR information screen.

**New Sensor** displays the date when a new sensor was last installed.

**Recent Cal** displays the most recent calibration date.

## 5.6 CLOCK/DELAY SETUP

Since the OLCT 200 is equipped with a Real Time Clock & Calendar **Time** and **Date** must be set to correctly match its location. They are set at the factory in a 24 hour format but may require adjustment to match the location's time & date after shipment. Follow the procedure in *Configuration Using the Magnetic Wand* in section 3.3.

**Warm Up** and **Cal Purge** time delays are also available to prevent unwanted alarm trips. Figure 5-9 shows the menu for these items.



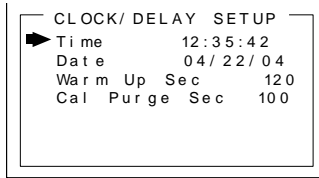

Figure 5-9: Clock & Calendar / Delay Timer Menu

## 5.7 LCD Contrast Adj

**LCD Contrast Adj.** may be set for optimum viewing using the menu shown in Figure 5-10.

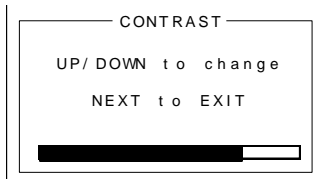

Figure 5-10: LCD Contrast Adjust Menu

## 5.8 HELP Screen

The **HELP** screen contains several pages of information describing how to operate the OLCT 200. This is the bottom menu on page 1 of the **SETUP** screen.

## 5.9 Diagnostics

**IMPORTANT:** Gas monitoring and alarm processing are not performed while using the Diagnostics menus. **Access requires a special key sequence of four consecutive UP keystrokes.**

There are two **Diagnostics** menus useful for driving outputs without exposing the sensor to the target gas. The **OUTPUT SIMULATION** menu allows setting the 4-20mA output to virtually any desired value. This is useful for checking responses of devices receiving the OLCT 200's 4-20mA output. The **ACTIVATE RELAYS** menu allows tripping of alarm relays (if equipped) without tripping alarm set-points with the target gas. This is useful for testing alarms events such as lights and audible devices.

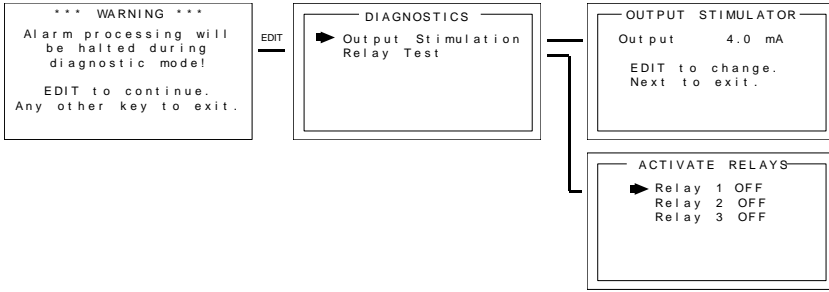

Figure 5-11: Diagnostics Menus

## 5.10 RS-485 / MODBUS SETUP

The **RS-485 MODBUS SETUP** menu allows setting the RTU address (if RS-485 equipped) for each OLCT 200 on the RS-485 network. Each OLCT 200 must have a different RTU address when communicating on the same 2-wire cable. Baud rate, Parity and Stop Bit are fixed at industry standard values of 9600, none ,1.

**Note:** If “Marker TX LED” is selected **RS-485 MODBUS SETUP** menu is not available, because the serial port is no longer active.

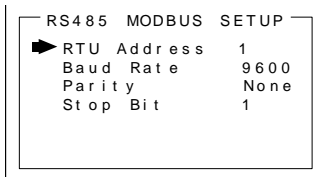

Figure 5-12: Modbus RS-485 Setup Menu

### 5.10.1 MODBUS REGISTER AND FUNCTION CODE SUMMARY

The following table identifies OLCT 200 Modbus register locations and function codes. “Chan 1” designations represent the EC channel while “Chan 2” represent the LEL / 4-20mA Input channel.

VARIABLE	ALIAS	READ FUNCTION CODE	WRITE FUNCTION CODE
<b>Read Only Discretes:</b>			
Chan 1 Alarm 1	2001	2	NA
Chan 1 Alarm 2	2002	2	NA
Chan 1 Fault	2003	2	NA
Chan 2 Alarm 1	2004	2	NA
Chan 2 Alarm 2	2005	2	NA
Chan 2 Fault	2006	2	NA
K1	2007	2	NA
K2	2008	2	NA
K3	2009	2	NA
Chan 1 Cal Mode	2010	2	NA
Chan 2 Cal Mode	2011	2	NA

**Read/Write Coils:**

Alarm Ack/Reset	12001	1	5
-----------------	-------	---	---

**Note:** After writing a TRUE to this register, it resets back to FALSE automatically.

**Read Only Registers:**

D2A Raw Chan 1	31001	4	NA
D2A Raw Chan 2	31002	4	NA

Calibrated 10 bit value representing the D2A value of 0 to 1023 for -25 to 105 %FS (200=0% & 1000=100%).

**IMPORTANT: READ REGISTERS 31001 / 31002 TO CREATE READINGS THAT MATCH OLCT 200 DISPLAY VALUES! THESE SHOULD ALSO BE READ BY THE WX16 MODBUS MASTERS.**

A2D Raw Chan 1	31003	4	NA
A2D Raw Chan 2	31004	4	NA

10 bit value representing the A2D value of 0 to 1023 before calibration constants are applied.

Chan 1 Status	31005	4	NA
Chan 2 Status	31006	4	NA

(16 bit status words; bit assignment for each channel)

<i>ALARM1_BELOW</i>	<i>BIT0</i>
<i>ALARM2_BELOW</i>	<i>BIT1</i>
<i>ALARM3_BELOW</i>	<i>BIT2</i>
<i>ALARM1_LATCH</i>	<i>BIT3</i>
<i>ALARM2_LATCH</i>	<i>BIT4</i>
<i>ALARM3_LATCH</i>	<i>BIT5</i>
<i>ALARM3_ACTIVE</i>	<i>BIT6</i>
<i>CHANNEL_DISABLED</i>	<i>BIT7</i>
<i>CHANNEL_CAL</i>	<i>BIT8</i>
<i>CHANNEL_LINEARIZE</i>	<i>BIT9</i>
<i>FAULT_RELAY_LATCH</i>	<i>BIT10</i>
<i>DISPLAY_NEGATIVE</i>	<i>BIT11</i>
<i>TRANSMIT SENSOR</i>	
<i>LIFE_ENABLED</i>	<i>BIT12</i>

Alarm Status Word	31007	4	NA
(16 bit status word; bit assignment for system status)			

CH1_ALM1	BIT0
CH1_ALM2	BIT1
CH1_FAULT	BIT2
CH2_ALAM1	BIT4
CH2_ALM2	BIT5
CH2_FAULT	BIT6
K1_STATUS	BIT8
K2_STATUS	BIT9
K3_STATUS	BIT10

Transmitter Status Word	31008	4	NA
(16 bit status word; bit assignment for system status)			

CHAN_1_ACTIVE	BIT0
CHAN_2_ACTIVE	BIT1
SECURE_LEVEL	BIT2
MARKER Tx LED	BIT3
K1_FAILSAFE	BIT12
K2_FAILSAFE	BIT13
K2_ACK	BIT14
LOCK	BIT15

Chan 1 Sensor Life	31009	4	NA
Chan 2 Sensor Life	31010	4	NA
(16 bit signed integer ranging from -1 to 100 where -1 indicates Cal Required)			

Chan 1 Sensor Temperature	31011	4	NA
Chan 2 Sensor Temperature	31012	4	NA
(16 bit integer ranging from 1 to 4095 scaled for -55 to +125 degrees C)			

**Memory Floating Point:**

**Note:** Returned as 15bit plus sign 2s complement with +/- 5% over/underrange applied. Consider over/underrange when scaling values to be displayed at the workstation. The following equation may be used to determine a value for display.

$$Display\ Value = \frac{MODBUS\ Value \cdot (Span\ Value - Zero\ Value) \cdot 1.1}{100} + \{Zero\ Value - [(Span\ Value - Zero\ Value) \cdot 0.05]\}$$

32767

FP Value Chan 1	33001	4	NA
FP Value Chan 2	33002	4	NA

**Memory ASCII Strings:**

User Info Chan 1	40401-40408	3	NA
User Info Chan 2	40409-40416	3	NA
16 ASCII characters (2 per register) assigned to the unit identifier read as bytes.			

Chan 1 ASCII Reading	40417-40419	3	NA
Chan 2 ASCII Reading	40420-40422	3	NA
6 ASCII characters (2 per register) reflecting the display readout.			

<b>VARIABLE</b>	<b>ALIAS</b>	<b>READ FUNCTION CODE</b>	<b>WRITE FUNCTION CODE</b>
-----------------	--------------	---------------------------	----------------------------

EUNITS Chan 1	40423-40427	3	NA
EUNITS Chan 2	40428-40432	3	NA

10 ASCII characters (2 per register) assigned to the engineering units read as bytes.

**Byte Variables:**

PreAmp/Gain Ch1	40433	3	NA
PreAmp/Gain Ch2	40434	3	NA

2 bytes representing Pre Amp (HiByte) and PGA (LoByte) settings.

**Firmware Version:**

Version	40435-40436	3	NA
---------	-------------	---	----

4 ASCII characters (2 per register) reflecting the firmware version.

**Memory Reals:**

**Note:** Real value represents float value without the decimal point such as 123.4 is returned as 1234. Decimal divisor is returned as 1, 10, 100, or 1000 for decimal position of 1, 2, 3, or 4, where 123.4 would return the value 10.

Chan 1 Cal Zero Real	41001	4	NA
Chan 1 Cal Zero Devisor	41002	4	NA
Chan 1 Cal Span Real	41003	4	NA
Chan 1 Cal Span Devisor	41004	4	NA
Chan 1 Zero Real	41005	4	NA
Chan 1 Zero Devisor	41006	4	NA
Chan 1 Span Real	41007	4	NA
Chan 1 Span Devisor	41008	4	NA
Chan 1 Fault Real	41009	4	NA
Chan 1 Fault Devisor	41010	4	NA
Chan 1 Alarm 1 Real	41011	4	NA
Chan 1 Alarm 1 Devisor	41012	4	NA
Chan 1 Alarm 2 Real	41013	4	NA
Chan 1 Alarm 2 Devisor	41014	4	NA
Chan 1 Alarm 3 Real	41015	4	NA
Chan 1 Alarm 3 Devisor	41016	4	NA
Chan 1 Manual Gain Real	41017	4	NA
Chan 1 Manual Gain Devisor	41018	4	NA
Chan 1 Manual Offset Real	41019	4	NA
Chan 1 Manual Offset Devisor	41020	4	NA
Chan 2 Cal Zero Real	41021	4	NA
Chan 2 Cal Zero Devisor	41022	4	NA
Chan 2 Cal Span Real	41023	4	NA
Chan 2 Cal Span Devisor	41024	4	NA
Chan 2 Zero Real	41025	4	NA
Chan 2 Zero Devisor	41026	4	NA
Chan 2 Span Real	41027	4	NA
Chan 2 Span Devisor	41028	4	NA
Chan 2 Fault Real	41029	4	NA
Chan 2 Fault Devisor	41030	4	NA

<b>VARIABLE</b>	<b>ALIAS</b>	<b>READ FUNCTION CODE</b>	<b>WRITE FUNCTION CODE</b>
-----------------	--------------	---------------------------	----------------------------

Chan 2 Alarm 1 Real	41031	4	NA
Chan 2 Alarm 1 Devisor	41032	4	NA
Chan 2 Alarm 2 Real	41033	4	NA
Chan 2 Alarm 2 Devisor	41034	4	NA
Chan 2 Alarm 3 Real	41035	4	NA
Chan 2 Alarm 3 Devisor	41036	4	NA
Chan 2 Manual Gain Real	41037	4	NA
Chan 2 Manual Gain Devisor	41038	4	NA
Chan 2 Manual Offset Real	41039	4	NA
Chan 2 Manual Offset Devisor	41040	4	NA

**Binary Cal Data:**

Chan 1 A2D MIN	41041	4	NA
Chan 1 A2D MAX	41042	4	NA
Chan 1 D2A MIN	41043	4	NA
Chan 1 D2A MAX	41044	4	NA
Chan 2 A2D MIN	41045	4	NA
Chan 2 A2D MAX	41046	4	NA
Chan 2 D2A MIN	41047	4	NA
Chan 2 D2A MAX	41048	4	NA

Min and Max calibration points for the A/D and D/A converters.

## 5.11 SYSTEM SECURITY

The **SYSTEM SECURITY** menu offers two levels of protection. A **LOW** level allows CAL MODE sensor calibrations but requires the 4-digit **Pass Code** prior to altering menus. **HIGH** level locks the entire menu database and the CAL Mode until the correct **Pass Code** is entered. **LOW** and **HIGH** security levels always allow viewing of configuration menus but they may not be changed. **Contact Name** is a 12 character ASCII field available for displaying a phone # or name of personal who know the **Pass Code**. Lost **Pass Codes** may be recovered by entering the locked security menu and holding the UP key for 5 seconds. The 4-digit code appears near the bottom of the screen.

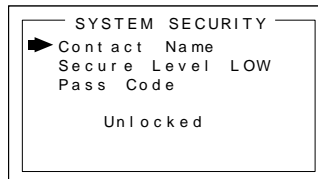

**Figure 5-13: System Security Menu**

# SECTION 6 - WIRELESS COMMUNICATION

## 6.1 Description of Client and Server Wireless Networks





OLCT 200 and WX series controller wireless transceivers utilize a FHSS (Frequency Hopping Spread Spectrum) Server-Client network where multiple Clients synchronize their frequency hopping to a single Server. The Server transmits a beacon at the beginning of every frequency hop (50 times per second). Client transceivers listen for this beacon and upon receiving it synchronize their hopping with the Server. OLCT 200's are often powered by a battery so care is taken to reduce power consuming RF transmissions to a minimum. OLCT 200's are never used for Server operation and are always Clients.

Each OLCT 200 wireless "broadcast" includes 10-bit monitored gas value, battery voltage and a status byte. This proprietary wireless protocol interfaces only to WX4, WX16, and WX64 Controllers. Controllers are capable of functioning as Clients or Servers but only one Server is allowed per wireless network. Multiple WX series controllers may receive the same transmissions from OLCT 200's, but only one controller per wireless network may be configured as the Server.

Each transceiver on a wireless network must have its **RADIO SETUP** menus configured to share the same **Hop Channel** and **System ID** in order to communicate (see section 6.5). There should never be two servers with the same **Hop Channel** / **System ID** settings in the same coverage area as the interference between the two servers will severely hinder RF communications. The Server must be in a powered location and should be centrally located since all Clients must receive the server's beacon in order to communicate.

Correct planning and design of wireless systems are imperative for ensuring a successful installation. It is highly recommended that a site drawing indicating location of monitors and base station, line of site obstructions, and sources of RF interference be submitted when requesting a quotation.



## 6.2 OLCT 200 Radio Status (RS) Icons , , , ,

Figure 2-1 shows the OLCT 200 data displays and identifies "radio status" (RS) icons which appear on the LCD. RS icons, along with the TXD led (see Figure 2-1), are useful diagnostic tools for evaluating RF communication. Status conditions indicated by the RS icon are **Sleep Mode - Zzz's**, **Server In Range** -  (server's beacon received at most recent attempt), **Server Out of Range** -  (server's beacon not received at most recent attempt), **Server Previously Out of Range** -  and **Low Battery** - . The Server "Previously Out of Range" icon is useful in determining if

intermittent communication failures are a result of this monitor having problems receiving the Server's beacon. The duration and frequency of "out of range" conditions are stored in the Event Log table described in Section 6.4. Low Battery conditions also flash the FAIL led.

It is important to understand RS icons only update as the TXD LED flashes indicating an RF transmission has occurred. RF transmissions are typically each 5-minutes, but increase to each 6-seconds during alarm conditions.

### 6.3 RF Comm Cycle and Power Consumption

Wireless systems are often battery powered therefore power consumption must be kept low. Most OLCT 200's power is consumed as the radio communicates to the wireless network. Each Comm cycle consists of the following operations: Awake the radio in receive mode; listen for the Server's beacon; synchronize to the Server's hopping frequency to become "In Range "; transmit data packet out the antenna and return to sleep mode. This sequence takes from .25 to 1 second to complete. If the radio fails to synchronize hopping upon the initial attempt it waits 6 seconds and tries again, then waits 6 seconds and tries once more. If the third attempt fails the "Out of Range " icon appears and OLCT 200 returns to its Comm cycle. Out of range will also be logged into the Event Log.

Every 6-seconds, the monitor performs a "sniff test" to detect level of target gas present at the sensor. At each "sniff test", the **Zzz's** "Sleep Mode" icon is briefly replaced by an RS icon as described above in section 2.2.1. At this time the readout updates to indicate gas value measured at the "sniff test". The radio stays OFF if the gas value does not trip A1 or A2 alarms. Except when the **Wakeup Time** menu expires (maximum of 5-minutes) the radio turns on, receives the Server's beacon, and transmits its data. These 5-minute transmissions allow the WX series controller to confirm a good wireless comm link even when no alarms exist. If A1 or A2 alarms do exist during the "sniff test", the radio wakes, receives the Server's beacon, and transmits its data immediately.

The following list identifies each of the conditions that cause the radio to transmit:

- Every 5-minutes (or faster depending upon **Wakeup Time** menu in section 6.7) when there is no A1 or A2 alarm. Important since the receiving controller reports "Comm Error" if the monitor does not reply for periods of greater than 18-minutes. A3 and FAIL alarms do not increase radio transmission rates.
- Every 6-seconds if there is an A1 or A2 level alarm.
- Upon entry into CAL MODE a 75 counts value (-15.6% FS) is transmitted. Receivers indicate "IN CAL" when 75 counts is the input for a channel (200 to 1000 counts represents 0 to 100% of full scale).
- Upon ENTRY into CAL PURGE a 200 counts value (0% FS) is transmitted. NOTE: To prevent A1 & A2 low trip alarms, oxygen ranges transmit 20.9% readings upon entry into CAL PURGE.



Holding the magnet to the UP key for >8 seconds forces a transmission of the current reading value.

## 6.4 #10-0299 OLCT 200 Battery I/O PCB with Power Switch

Battery powered wireless OLCT 200 electronics consists of the lower 10-0299/Battery I/O PCB (Figure 2-3) connected by a cable to the upper Display assembly with 10-0291 RF Module PCB (Figure 2-3). The 10-0293 3.6 volt lithium 'D' cell battery will continuously power the unit for up to one year and may be replaced by following the procedure in Figure 6-1.

Power switch (SW1), on the 10-0299 Battery PCB, applies battery power to the OLCT 200 monitor. SW1 should be OFF if the monitor is to be out of service for long periods.

**IMPORTANT:** Do not turn SW1 ON until the controller designated as Server is fully operational and ready to communicate to the OLCT 200. Battery life is reduced if the OLCT 200 is on for long periods while unable to communicate to the Server controller.

**IMPORTANT:** DO NOT ATTEMPT TO CHARGE THIS BATTERY OR REPLACE WITH ANY OTHER THAN PART # 10-0293 FROM OLDHAM.

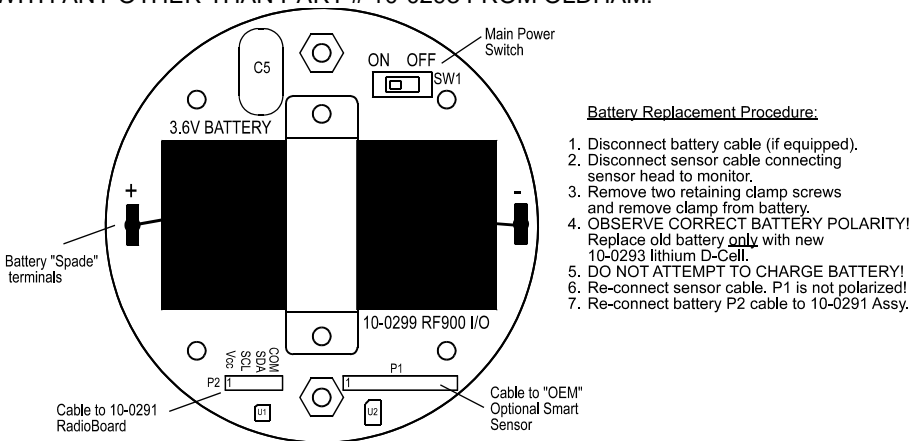

Figure 6-1: 10-0299/Battery I/O PCB

## 6.5 WIRELESS COMMUNICATION SETUP

The **Communications** menu provides access to **RADIO SETUP** menus described below. **Hop Channel** and **System ID** settings must match these settings in the Server. **Remote ID** must be unique to each OLCT 200. Items tagged with an asterisk affect power consumption and may have significant effects upon battery life.

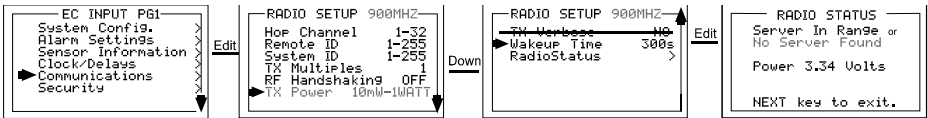

Figure 6-2: Radio Setup Menu

- *Hop Channel* may be set from 1-32 and assigns the pseudo-random radio frequency hopping pattern. A transceiver will not go In Range of or communicate with a transceiver operating on a different Hop Channel. Different hop channels can be used to prevent radios in one network from listening to transmissions of another. Installations having more than one Server network should also have different hop channels for each network.

**2.4GHZ variation:** Hop channels on 2.4 GHZ models may be set between 0 and 39. Hop channels 0-19 includes EU “low band” frequencies 2406 – 2435MHZ. Hop channels 20-39 includes EU “high band” frequencies 2444 – 2472MHZ.

**IMPORTANT!! EXPLORE WHAT FREQUENCIES ARE APPROPRIATE FOR THE FINAL LOCATION OF ANY WIRELESS SYSTEM.**

- *Remote ID* may be set from 1-255 and acts as the “RTU” address for this particular OLCT 200. Controller channels receiving this monitor’s data must also be configured with this matching Remote ID address.
- *System ID* may be set from 1-255 and is similar to a password character or network number and makes network eavesdropping more difficult. A transceiver will not go In Range of or communicate with a transceiver operating on a different System ID.
- *\*TX Multiples* allows up to 5 consecutive repeats of EVERY transmission. The default setting of 1 should only be increased if there is no other way to improve communications success. Power consumption increases with radio transmissions and battery life will be affected by raising the TX Multiples setting.
- *\*RF Handshaking* affects the way RF transmissions are made by the OLCT 200. This menu may be set for **OFF** (default) or **ON**. **OFF** requires no acknowledge from the receiving server. **ON** should be used only when transmitting to a single receiving server (such as WX4, WX16 or WX64). Since **ON** creates an “acknowledge” hand shake returned from the receiver, only one receiver is allowed to avoid data collisions of the “acknowledge” signal. If an “acknowledge” is not received by the OLCT 200 it transmits repeatedly up to 16 times.  
RF HANDSHAKING = **OFF** may be used for any application but is required when transmitting to a Server and other receiver Client radios (Example is

with an WX16 Controller as server along with additional Relay Modules, WX16 and WX4 Clients). RF HANDSHAKING = **ON** always transmits the packet 4 times and does not require any “acknowledge” returned by the receivers.

- **\*TX Power** (900MHZ models only) may be set for 10 mW, 200mW, 400mW and 1 watt. Since some OLCT 200's are battery powered the TX Power setting should be as low as possible to sustain reliable communication. The maximum TX Power setting is 30db (1 watt) and each time TX power is reduced by half, antenna transmit power is reduced by 3dB.  
**2.4GHZ variation: The TX Power menu is not available in 2.4GHZ models and is fixed at 50mW.**
- **TX Verbose** is unavailable for firmware revisions 3.09 and earlier.
- **Wakeup Time** menu is new to firmware revision 3.09 and determines how often the radio is activated WHEN THERE IS NOT AN A1 or A2 LEVEL ALARM. The default value is 300 seconds (5 minutes) but this may be reduced to as low as 6 seconds. Intervals are rounded up to the nearest 6 seconds regardless of the menu entry (example: 50 second entry transmits every 54 seconds).  
**IMPORTANT:** More frequent RF transmissions deplete the battery faster!
- **Radio Status** opens a page indicating if the OLCT 200 is In Range of the Server. A voltage reading on this page displays the internal 3.3V power supply value.

**TX Multiples, RF Handshaking** and **TX Power** menu settings are available to improve communications reliability by increasing the quantity and power of wireless transmissions.

**IMPORTANT!** Ensure proper selection and location of antennas before increasing **TX Multiples** and **TX Power** settings! Battery life will be reduced by increasing these settings. Proper selection and location of antennas contributes much more to successful communications, without sacrificing battery life, than these settings.

### 6.5.1 OLCT 200 AND WX16 BASE STATIONS

**Figure 6-3 shows correct settings for the WX16 base station's “Data From” menu to receive data from OLCT 200's.** Each WX16 channel's Remote ID must match the OLCT 200's Remote ID setting (see section 6.7) in order for its VALUE to appear on the desired WX16 channel. The OLCT 200 counts value equals 75 counts, or -15.6%, during CAL MODE. Enabling the WX16's “INPUT MARKER” menu as shown on the right menu in Figure 6-3 causes the WX16 to indicate IN CAL when the OLCT 200 has its CAL MODE activated.

**Input Req** set for VALUE means this WX16 channel reads the OLCT 200's monitored gas value. If the **Input Req** menu is set for BATT this WX16 channel reads the battery voltage from the OLCT 200 with the same Remote ID. To properly display an OLCT 200's battery voltage the WX16 engineering unit range should be 0-5.00 VDC. Even if this channel reads VALUE from the OLCT 200, the battery voltage is displayed at the bottom of this WX16 menu as shown in Figure 6-3.

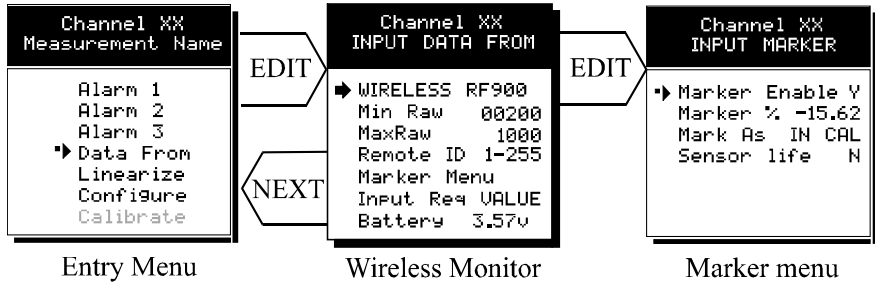

**Figure 6-3: WX16 Base Station “Data From” Menu**

### 6.5.2 OLCT 200 AND WX4 BASE STATIONS

FIGURES 6-4 and 6-5 show correct settings for a WX4 base station to receive data from OLCT 200's.



**Figure 6-4**

WX4 base stations must have their Communications menus set for Wireless Receiver mode as shown in Figure 6-4. In Receiver mode the WX4 may have 1-4 channels configured to receive input data from 1-4 OLCT 200 sensor transmitters.

Channel input type is configured in the ANALOG SETUP menu located within the Input/Output Setup menus as shown in Figure 6-5. OLCT 200's transmit 200 counts for 0% and 1000 counts for 100% full scale readings so Input Min/Max menu values should be 200 & 1000. The Rmt. Xmitter ID menu entry must match the Remote Id address setting in the OLCT 200 providing data to this WX4 channel. Voltage level of the 3.6 volt lithium battery in this OLCT 200 is also displayed on this screen. The most recent A/D Counts value is displayed at bottom of the screen.

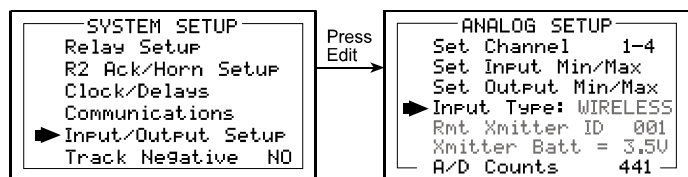

A/D Counts, at bottom, are most recent transmitted value from the wireless monitor

Figure 6-5



# SECTION 7 - TECHNICIANS ONLY MENUS

## 7.1 Introduction

**WARNING!** Users of these menus must have a detailed understanding of their functions. Monitoring of target gases, processing of alarms, 4-20mA output values, Modbus RS-485 and wireless communications should not be relied upon while editing these menus! Back-up the current configuration prior to altering any Technical menus in case Restore is required later (see section 5.3).

The **TECHNICIAN ONLY** menu group contains items that are **factory configured** depending upon the type sensor and input connected to the OLCT 200. They should not be tampered with after installation. If configured incorrectly, some items will prevent monitoring of target gases. **The Set Sensor Voltage** menu for setting the catalytic bead sensor excitation voltage could destroy the sensor. **Access requires a special key sequence of four consecutive UP keystrokes** to prevent accidental modification of critical items.

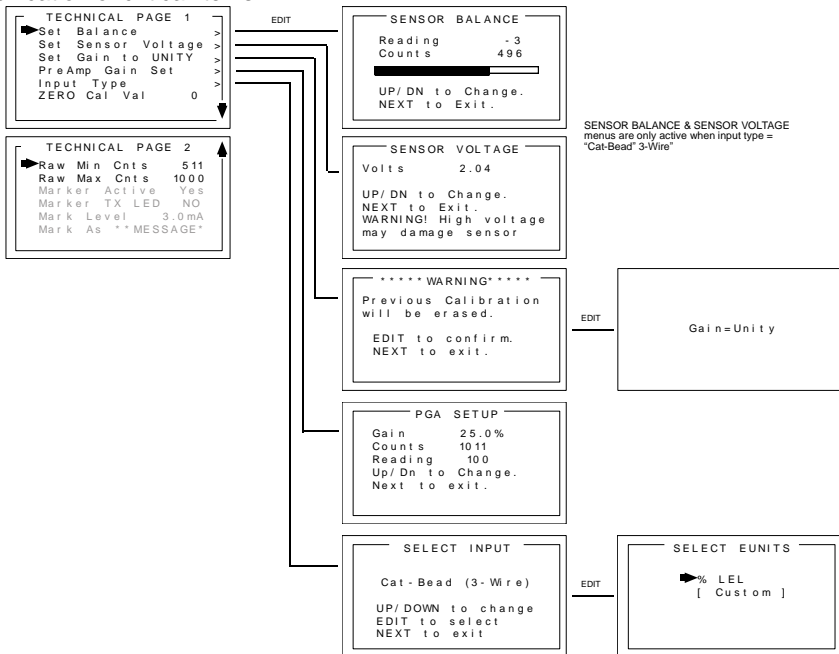

Figure 7-1a: Technicians Menu Tree- Wired Models

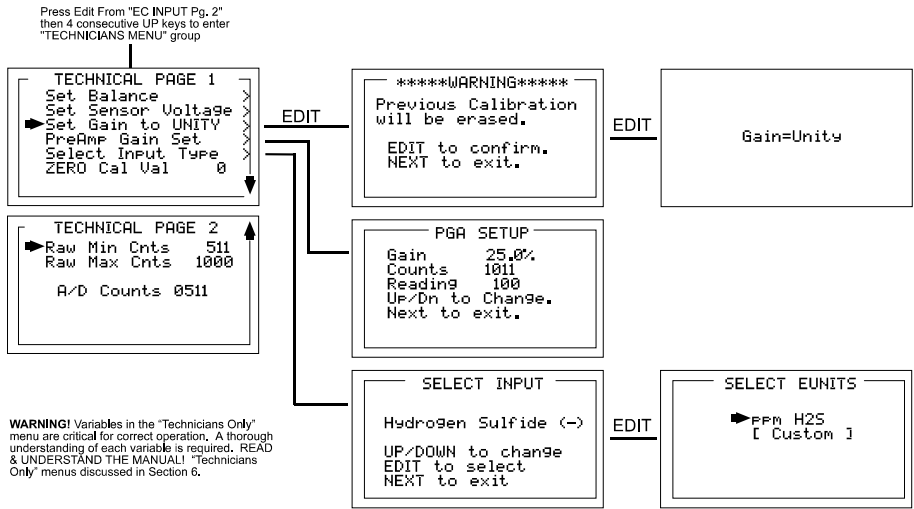

Figure 7-1b: Technicians Menu Tree- Wireless Models

## 7.2 Set Balance / Set Sensor Voltage (Technicians only!)

**Set Balance** and **Set Sensor Voltage** are used when **Input Type** is for *Bridge* sensors. They are **factory configured** and only require field adjustment if the catalytic bead sensor is mounted remote from the OLCT 200 or if a new sensor is installed. Other input type entries draw a line through these menus and they are inactive. OLCT 200 bridge sensors may be from 2 to 6 volts excitation voltage **at the sensor**. This means if the sensor is mounted a long distance away the voltage at the OLCT 200 may have to be higher to compensate for losses in field wiring. Be careful not to exceed correct sensor volts at the sensor's A and R terminals.

**Set Balance** allows balancing of the catalytic bead sensor and must only be performed with ZERO gas on the sensor (Figure 7-2). Balance is similar to a very coarse ZERO calibration and does not need to be precise since subsequent calibrations will correct for small errors. ZERO gas applied to the sensor should provide a Reading of -3 to +3 on the SENSOR BALANCE menu.



SENSOR BALANCE & SENSOR VOLTAGE  
menus are only active when input type =  
"Cat-Bead" 3-Wire"

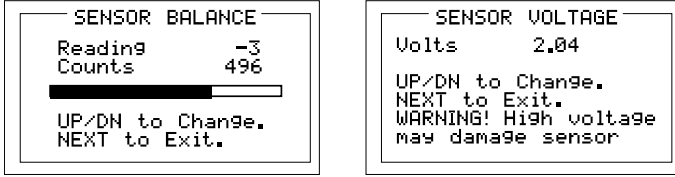

Figure 7-2: Catalytic Bead BALANCE & SENSOR VOLTS Adjust Menus

### 7.3 Set Gain to Unity (Technicians only!)

**Set Gain to UNITY** allows resetting previous calibration OFFSET to zero and GAIN to one. This is the definition of UNITY. A calibration should be performed after setting UNITY.

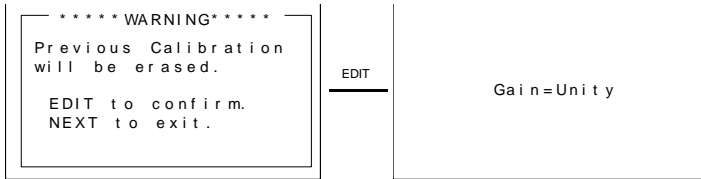

Figure 7-3: Set UNITY GAIN Menu

### 7.4 PreAmp Gain Adjust (Technicians only!)

Depending upon **Input Type**, OLCT 200 inputs range from a few micro amps to hundreds of micro amps. **PreAmp Gain Set** is the adjustment that matches the input signal range to the OLCT 200 input signal conditioning circuits. Altering the PreAmp Gain setting automatically resets previous calibration OFFSET & GAIN values to UNITY as described in section 7.3.

If it is determined the PreAmp Gain value is incorrect, apply the desired up-scale input and use the UP / DOWN keys to obtain the correct **Reading** value. **Counts** are the 10-bit binary A/D value with an active range value of 0 - 1023.

**CAUTION:** For standard installations, this is a factory adjustment. Do not use the **PreAmp Gain Set** menu for calibrating sensors. It should only be adjusted if a new measurement gas or input range is required.

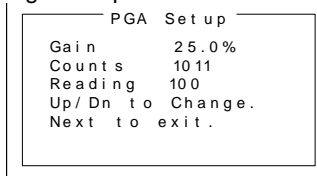

Figure 7-4: PreAmp Gain Adjust (PGA) Menu

## 7.5 Zero Cal Value (Technicians only!)

The **Zero Cal Value** menu entry allows the zero calibration value to be set for something other than a zero reading. For example, a OLCT 200 4-20mA input may represent a BTU Analyzer range of 500 – 1000 BTU's. In this case, 0% of full scale equals 500 BTU's and may be the desired zero calibration point. Other upscale values may also be used for the zero calibration point by setting this menu item to the desired engineering unit value. Do not exceed 25% of full scale.

## 7.6 Raw Min / Max Counts (Technicians only!)

The **Raw Min / Max Counts** menus determine the range of 10-bit analog to digital (A/D) converter counts that define 0 & 100% of full scale. Raw Min A/D counts create 0% readings and Raw Max A/D counts create 100% readings. These menus are very useful in application with non-standard input ranges. For example, for wired models, if instead of a standard 4-20mA input 8-18mA must be accepted by the OLCT 200. Set RAW MIN COUNTS to match the 8mA input counts value and RAW MAX COUNTS to match the 18mA input counts value. The corresponding **Zero 0%** and **Span 100%** readings are entered in the Configuration Menu describe in section 5.3. Live A/D count values may be viewed from the CAL MODE Information screen described section 4.1.

# SECTION 8 - ARCTIC CONFIGURATIONS

## 8.1 ARCTIC Option

OLCT 200 3-wire models may be ordered with a special *ARCTIC* configuration to include a 175 ohm 4-watt heater / temperature controller circuit mounted to the back of the 10-0233 Power Supply PCB (Figure 2-5). In addition, when equipped with a locally mounted 10-0247 Smart Sensor Head (Figure 2-16) ARCTIC Smart sensors are available with a 1-watt heater / temperature controller for warming the sensor compartment. This is important since many electrochemical sensors have a low temperature rating of only -20C. If incoming 10-30VDC power is at least 24VDC, the ARCTIC option extends OLCT 200 operation down to -55C.

**Important! ARCTIC OLCT 200's consume more power when it is cold!** When temperature inside the OLCT 200 enclosure is below -25C the 175 ohm 10-0233 PCB heater is connected across the incoming DC power terminals. When an ARCTIC Smart Sensor is installed, its 1-watt heater is connected across the OLCT 200's internal 5VDC power supply when Sensor Temp is below the Setpoint (see section 8.1.1). These additional loads must be considered when sizing the installation's DC power supply.

### 8.1.1 ARCTIC Smart Sensor Temperature Setpoint Option

Both the O2/TOXIC and LEL/Current channels (see section 3.1.1) are capable of accepting ARCTIC Smart Sensors with 1-watt heater / temperature controller circuits. ARCTIC sensor temperature controllers have a unique address that is automatically detected by the OLCT 200. This activates the **Sensor Temp** menu on page 2 of the channel's main menu as shown below in Figure 8-1. Selecting **Sensor Temp** and pressing EDIT opens a window displaying the sensor's current temperature and the 1-watt heater's **Setpoint**. When the **Sensor Temp** value is below the **Setpoint** value the heater is on. This feature is helpful in applications where the sensor temperature must be higher than the ambient temperature to function properly.

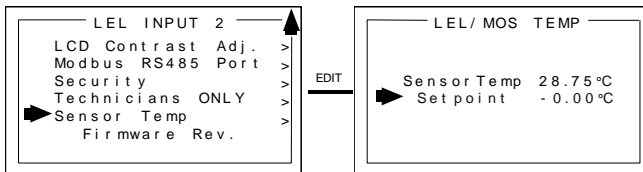

Figure 8-1: ARCTIC Sensor Temperature Menu

Entering **YES** in the **Marker Active** menu also activates **Marker TX LED**, **Mark Level**, and **Mark As** menus. **Mark Level** allows entering the <3.75mA value ( $\pm 2mA$ ) to detect. **Mark As** allows entry of the up to 10 digit ASCII message the LCD readout will display when the **Marker** is detected. **Marker TX LED** menu = YES, causes the front

panel TXD LED (see Figure 2-1) to also illuminate when the **Marker** is detected.

**Important: Optional 10-0234 RS-485 modbus port will not function if “Marker TX LED” menu must = YES.**

# SECTION 9 - SENSORS

## 9.1 Catalytic Bead (LEL) Sensors

Factory Default Settings

Ref #	Gas	Range	Resolution	Cal Gas	Low Alarm	High Alarm
10	Combustible, LEL, Methane Cal	0-100% LEL	1% LEL	50% LEL	10% LEL	20% LEL
11	Combustible, LEL, Pentane Cal	0-100% LEL	1% LEL	25% LEL	10% LEL	20% LEL
12	Combustible, LEL, Hydrogen Cal	0-100% LEL	1% LEL	25% LEL	10% LEL	20% LEL

## 9.2 Infrared (IR) Sensors

Factory Default Settings

Ref #	Gas	Range	Resolution	Cal Gas	Low Alarm	High Alarm
20	CO2	0-5% Vol	0.1% Vol	2.5% Vol	0.5% Vol	1.0% Vol
21	Methane, LEL	0-100% LEL	1% LEL	50% LEL	10% LEL	20% LEL
22	Propane, LEL	0-100% LEL	1% LEL	25% LEL	10% LEL	20% LEL
26	Ethylene, LEL	0-100% LEL	1% LEL	50% LEL	10% LEL	20% LEL

### 9.2.1 IR-Methane Sensor

The methane IR sensor is only intended to monitor methane gas. As seen in Figure 9.1, the cross-sensitivity of the methane IR sensor does not permit accurate measure of other combustible gases. It should be noted however, that the Methane-IR sensor WILL respond to other combustible gases and is not Methane specific.

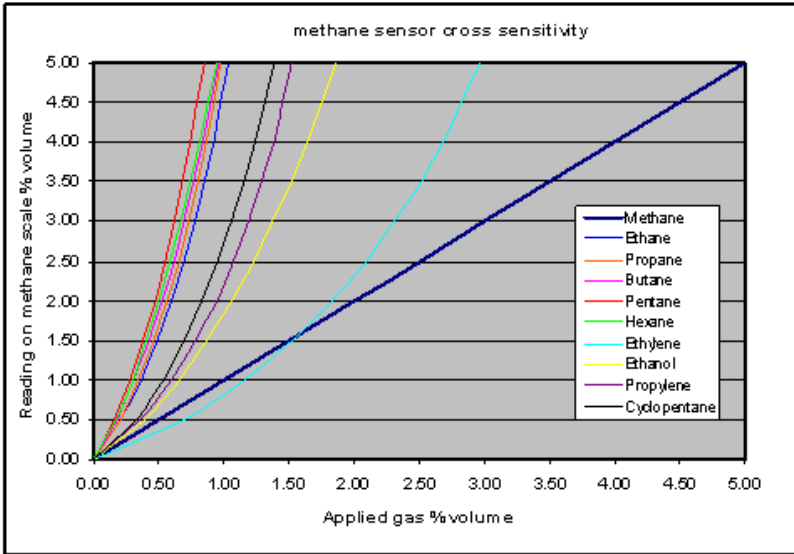

Figure 9-1 Cross-sensitivity chart for OLCT 200Methane IR Sensor.

The output of the IR sensor can be disrupted by sudden changes in temperature. If there is an excessive change in the ambient temperature, gas sample temperature or flow rate, then the output signal will be momentarily frozen. Correct operation is restored when the effects of the transient have settled. Rates of change in the ambient temperature should be restricted to 2°C/minute and gas flow rates kept below 0.6 L/minute.

Extreme pressure variations will cause errors in readings. The unit should be recalibrated if the atmospheric pressure change is greater than 10% from the original pressure.

Do not expose the sensor to corrosive gases such as Hydrogen Sulphide.

Do not allow condensation to occur inside the sensor.

### 9.2.2 IR-Propane Sensor

The propane IR sensor is factory configured to accurately monitor propane gas. As seen in Figure 9-2, the cross-sensitivity of the propane IR sensor does permit accurate measure of other combustible gases via a cross-reference factor. It should be noted however, that the Propane-IR sensor WILL respond to other combustible gases and is not Propane specific.

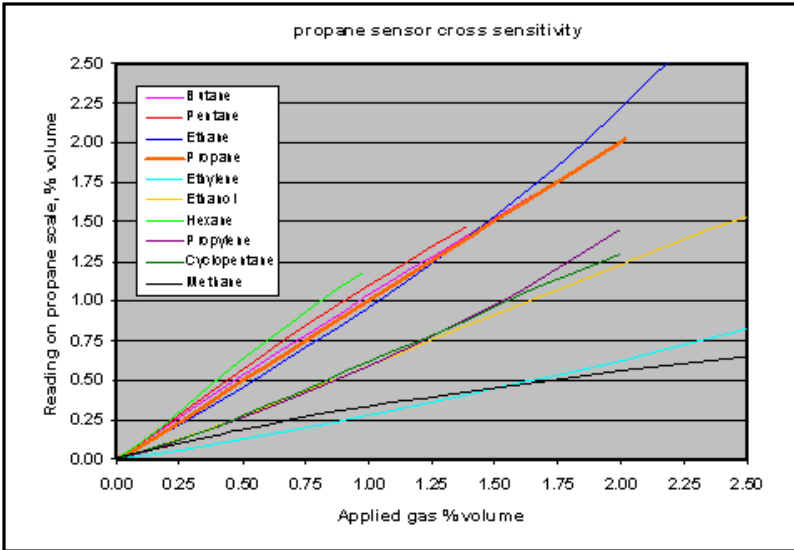

Figure 9-2 Cross-sensitivity chart for OLCT 200 Propane IR Sensor.

The output of the IR sensor can be disrupted by sudden changes in temperature. If there is an excessive change in the ambient temperature, gas sample temperature or flow rate, then the output signal will be momentarily frozen. Correct operation is restored when the effects of the transient have settled. Rates of change in the ambient temperature should be restricted to 2°C/minute and gas flow rates kept below 0.6 L/minute.

Extreme pressure variations will cause errors in readings. The unit should be recalibrated if the atmospheric pressure change is greater than 10% from the original pressure.

Do not expose the sensor to corrosive gases such as Hydrogen Sulphide.

Do not allow condensation to occur inside the sensor.

### 9.2.3 IR-CO2 Sensor

The CO2 IR sensor is factory configured to accurately monitor Carbon Dioxide gas. The output of the IR sensor can be disrupted by sudden changes in temperature. If there is an excessive change in the ambient temperature, gas sample temperature or flow rate, then the output signal will be momentarily frozen. Correct operation is restored when the effects of the transient have settled. Rates of change in the ambient temperature should be restricted to 2°C/minute and gas flow rates kept below 0.6 L/minute.

Extreme pressure variations will cause errors in readings. The unit should be recalibrated if the atmospheric pressure change is greater than 10% from the original pressure.

Do not expose the sensor to corrosive gases such as Hydrogen Sulphide.

Do not allow condensation to occur inside the sensor.

### 9.2.4 IR-Ethylene Sensor

The Ethylene IR sensor is factory configured to accurately monitor Ethylene gas. The output of the IR sensor can be disrupted by sudden changes in temperature. If there is an excessive change in the ambient temperature, gas sample temperature or flow rate, then the output signal will be momentarily frozen. Correct operation is restored when the effects of the transient have settled. Rates of change in the ambient temperature should be restricted to 2°C/minute and gas flow rates kept below 0.6 L/minute.

Extreme pressure variations will cause errors in readings. The unit should be recalibrated if the atmospheric pressure change is greater than 10% from the original pressure.

Do not expose the sensor to corrosive gases such as Hydrogen Sulphide.

Do not allow condensation to occur inside the sensor.

## 9.3 Photoionization Detection (PID) Sensors

### Factory Default Settings

Ref #	Gas	Range	Resolution	Cal Gas	Low Alarm	High Alarm
30	Volatile Organic Compounds	0-500ppm	1 ppm	100 ppm (Isobutylene)	100 ppm	200 ppm

### ! Caution ! Note on Silicones:

PIDs are not permanently damaged by Silicones but they can potentially harm the windows of the lamps and reduce response to some gases. This can usually be



addressed by polishing the lamp window with alumina powder. See cleaning kit P/N 78105025

## Effect of Temperature

The response of the OLCT200 PID can be significantly affected by temperature. Most significantly, in environments below 0°C the measurement can be +50% or more of the actual gas concentration. As a result, it is highly recommended that OLCT200 PID be calibrated often and when seasonal temperature changes occur.

## Effect of Humidity

Water is not itself detected by PID; However, water absorbs a portion of the light that otherwise promotes a response from a photo-ionizable gas.

The response of the OLCT200 PID to humidity can be seen in the figures presented below, for Fahrenheit and Celsius temperatures. For example, it can be seen that at 80°F and 90% relative humidity (RH), a response is decreased from that in dry air by 20%. This effect will be the same for any detectable gas.

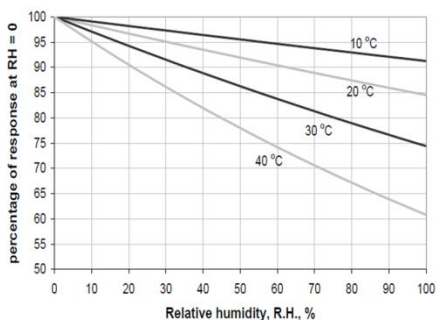
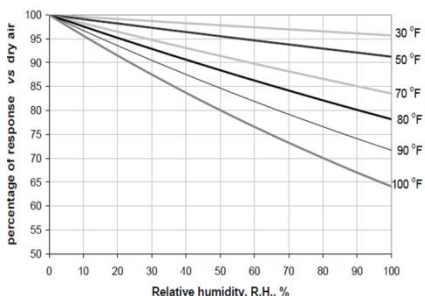

## Maintenance

The electronics in the OLCT200 PID sensor are designed to be maintenance-free and not accessible. Periodic sensor maintenance is required for the Mini Pellet and the lamp.

The OLCT200 PID lamp will need occasional cleaning. How often depends on the environment you are measuring. If you are measuring indoor air quality where the VOC concentrations are low and there are few particulates, then a monthly or even less frequent calibration may be adequate. However, if you are measuring high VOC concentrations and particulates are present in high concentration then check calibration frequently and when the PID has lost sensitivity or error state shows, change the stack as explained below.

Signs when the PID needs attention:

- If the baseline climbs after you zero the PID, then the electrode stack needs replacing.
- If the PID becomes sensitive to humidity, then the electrode stack needs replacing.
- If the baseline shifts/unstable when PID moves, then electrode stack needs replacing.
- If sensitivity has dropped too much (note the change required when checking calibration), then the lamp needs cleaning.

### Lamp Cleaning

Inspection of the lamp may reveal a layer of contamination on the detection window that presents itself as a 'blue hue.' To check for contamination, hold the lamp in front of a light source and look across the window surface

Only clean the lamp using the recommended lamp cleaning kit and detailed instructions. To avoid contaminating the sensor and affecting accuracy, do not touch the lamp window with bare fingers. You may touch the lamp body with clean fingers.

### PID lamp cleaning kit (P/N 78105025)

The vial of cleaning compound contains alumina (CAS Number 1344-28-1) as a very fine powder. Cleaning should be undertaken in a well-ventilated area. A full material safety data sheet MSDS is available on request from Ion Science Ltd. Key safety issues are identified below:

#### Handling:

- Do not breathe in the powder. Avoid contact with skin, eyes and clothing
- Wear suitable protective clothing
- Follow industrial hygiene practices: Wash face and hands thoroughly with soap and water after use and before eating, drinking, smoking or applying cosmetics.

#### Hazard identification:

- May cause irritation of respiratory tract and eyes

#### Storage:

- Keep container closed to prevent water adsorption and contamination.

### Cleaning the Lamp

Use of PID lamp cleaning P/N 78105025

1. Open the container of alumina polishing compound.
2. With a clean cotton bud, collect a small amount of the powder.



3. Use this cotton bud to polish the PID lamp window. Use a circular action, applying light pressure to clean the lamp window. Do not touch the lamp window with fingers.
4. Continue polishing until an audible “squeaking” is made by the cotton bud moving over the window surface. (usually within 15 seconds)
5. Remove the residual powder from the lamp window with a clean cotton bud. Care must be taken not to touch the tips of cotton buds that are to be used to clean the lamps as this may contaminate them with finger print oil.
6. Ensure the lamp is completely dry and any visible signs of contamination are removed before refitting.

## Replacing Lamp and Electrode Stack

### Discarding the PID pellet

Discard the contaminated electrode stack. The electrode stack does not have any toxic components, but if it has been contaminated by toxic materials, then show due care when disposing.

### Re-fitting PID pellet and lamp

#### Caution! Never refit a damaged lamp

1. Place the lamp inside the O-ring seal in the pellet as illustrated. Twist the lamp slightly during insertion to ensure the lamp window is snug against the pellet’s front electrode. The lamp should be freely supported by the O-ring.

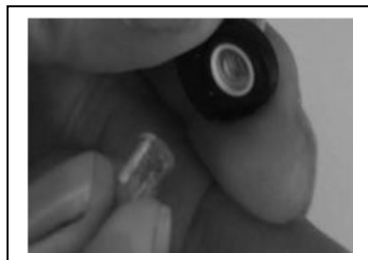

2. Lay the pellet front face down on a clean, flat surface and then screw the lamp down into the O-ring until it firmly abuts against the front electrode face – this is most important. Then bring the PID body carefully down over the lamp so as not to disturb its positioning within the pellet and then push the body firmly onto the pellet face down so that it clicks into place.

3. Refit the sensor into the sensing equipment.

4. Re-calibrate the OLCT200 PID

## Replacement Parts

**78105024 – Service Kit** (Includes electrode stack, 10.6eV bulb, bulb spring, and extraction tool.)

**78105025 – Cleaning Kit** (Includes lamp cleaning kit and extraction tool.)

## 9.4 Electrochemical Sensors

### Factory Default Settings

Ref #	Gas	Range	Resolution	Cal Gas	Low Alarm	High Alarm
41	Chlorine (Cl <sub>2</sub> )	0-50ppm	0.1ppm	10ppm	0.5ppm	1.0ppm
43	Carbon Monoxide (CO)	0-100ppm	1ppm	100ppm	35ppm	70ppm
44	Carbon Monoxide (CO)	0-300ppm	1ppm	100ppm	35ppm	70ppm
48	Hydrogen Sulfide (H <sub>2</sub> S)	0-30ppm	1ppm	25ppm	10ppm	20ppm
49	Hydrogen Sulfide (H <sub>2</sub> S)	0-100ppm	1ppm	25ppm	10ppm	20ppm
50	Hydrogen Chloride (HCl)	0-30ppm	0.1ppm	10ppm	5ppm	10ppm
54	Ammonia (NH <sub>3</sub> )	0-100ppm	1ppm	25ppm	25ppm	50ppm
55	Ammonia (NH <sub>3</sub> )	0-500ppm	1ppm	50ppm	25ppm	50ppm
60	Nitrogen Dioxide (NO <sub>2</sub> )	0-30ppm	0.1ppm	5ppm	1.0ppm	2.0ppm
61	Oxygen (O <sub>2</sub> )	0-30%vol	0.1% Vol	20.9%	19.5%	23.5%
66	Sulfur Dioxide (SO <sub>2</sub> )	0-30ppm	0.1ppm	5ppm	2.0ppm	4.0ppm

## 9.5 Spare Sensors

<b>OLCT 200 Replacement Sensors (without Arctic Heater)</b>	
<b>Part Number</b>	<b>Description</b>
78105008-10A	10 = LEL 0-100% (Catalytic Bead) (Methane Cal)
78105008-11A	11 = LEL 0-100% (Catalytic Bead) (Pentane Cal)
78105008-12A	12 = LEL 0-100% (Catalytic Bead) (Hydrogen Cal)
78105007-20A	20 = Carbon Dioxide 0 - 5% Vol (IR)
78105007-21A	21 = Methane 0 -100% LEL (IR)
78105007-22A	22 = Propane 0 -100% LEL (IR)
78105007-26A	26 = Ethylene 0 -100% LEL (IR)
78105007-27A	27 = Ethylene oxide 0 -100% LEL (IR)
78105006-30A	30 = VOC's (PID)
78105005-41A	41 = Chlorine (Cl <sub>2</sub> ) 0 10.0ppm (EC)
78105005-43A	43 = Carbon Monoxide(CO) 0 - 100ppm (EC)
78105005-44A	44 = Carbon Monoxide (CO) 0 - 300ppm (EC)
78105005-48A	48 = Hydrogen Sulfide (H <sub>2</sub> S) 0 - 30.0ppm (EC)
78105005-49A	49 = Hydrogen Sulfide (H <sub>2</sub> S) 0 - 100ppm (EC)
78105005-50A	50 = Hydrogen Chloride (HCl) 0 - 30ppm (EC)
78105005-54A	54 = Ammonia (NH <sub>3</sub> ) 0 - 100ppm (EC)
78105005-55A	55 = Ammonia (NH <sub>3</sub> ) 0 - 500ppm (EC)
78105005-60A	60 = Nitrogen Dioxide (NO <sub>2</sub> ) (0 - 30.0ppm) (EC)
78105005-61A	61 = Oxygen (O <sub>2</sub> ) 0 - 30% Vol (EC)
78105005-66A	66 = Sulfur Dioxide (SO <sub>2</sub> ) 0 -30.0ppm (EC)

## **OLCT 200 Replacement Sensors (with Arctic Heater)**

<b>Part Number</b>	<b>Description</b>
78105007-20B	20 = Carbon Dioxide 0 - 5% Vol (IR)
78105007-21B	21 = Methane 0 -100% LEL (IR)
78105007-22B	22 = Propane 0 -100% LEL (IR)
78105007-26B	26 = Ethylene 0 -100% LEL (IR)
78105007-27B	27 = Ethylene Oxide 0 -100% LEL (IR)
78105006-30B	30 = VOC's (PID)
78105005-41B	41 = Chlorine (Cl <sub>2</sub> ) 0 10.0ppm (EC)
78105005-43B	43 = Carbon Monoxide(CO) 0 - 100ppm (EC)
78105005-44B	44 = Carbon Monoxide (CO) 0 - 300ppm (EC)
78105005-48B	48 = Hydrogen Sulfide (H <sub>2</sub> S) 0 - 30.0ppm (EC)
78105005-49B	49 = Hydrogen Sulfide (H <sub>2</sub> S) 0 - 100ppm (EC)
78105005-50B	50 = Hydrogen Chloride (HCl) 0 - 30ppm (EC)
78105005-54B	54 = Ammonia (NH <sub>3</sub> ) 0 - 100ppm (EC)
78105005-55B	55 = Ammonia (NH <sub>3</sub> ) 0 – 500ppm (EC)
78105005-60B	60 = Nitrogen Dioxide (NO <sub>2</sub> ) (0 - 30.0ppm) (EC)
78105005-61B	61 = Oxygen (O <sub>2</sub> ) 0 - 30% Vol (EC)
78105005-66B	66 = Sulfur Dioxide (SO <sub>2</sub> ) 0 -30.0ppm (EC)





## **EUROPEAN PLANT AND OFFICES**

Z.I. Est – rue Orfila CS 20417 – 62027 Arras Cedex FRANCE

Tél: +33 (0)3 21 60 80 80 – Fax: +33 (0)3 21 60 80 00

Website: <http://www.oldhamgas.com>

### **AMERICAS**

Tel: +1-713-559-9280

Fax: +1-281-292-2860

[americas@oldhamgas.com](mailto:americas@oldhamgas.com)

### **ASIA PACIFIC**

Tel: +86-21-3127-6373

Fax: +86-21-3127-6365

[sales@oldhamgas.com](mailto:sales@oldhamgas.com)

### **EUROPE**

Tel: +33-321-608-080

Fax: +33-321-608-000

[info@oldhamgas.com](mailto:info@oldhamgas.com)