

## Single-Channel Safety Barriers with Electronic Current Limitation Series 9004

- Broad product range for all standard applications in the world of automation
- Flexible and space saving
- Time saving installation due to
  - simple snap on DIN-Rail and
  - connection to PE and ground at the same time
- Installation possible in Zone 2 and Division 2
- Reduced inventory due to uniform exchangeable fuse

	Zones					
	0	1	2	20	21	22
Ex i Interfaces		X	X		X	X
Installation in			X			X

**STAHl**

R.STAHl safety barriers INTRINSPAK series 9004 are used for various applications.

Because of the electronic current limitation these barriers are suitable for the intrinsic safe power supply of field devices.

The barriers of the series 9004 offering a smaller series resistance and therefore more power on the intrinsic safe side compared to the safety barrier series 9001 and 9002.

A broad range of versions are available for electrical circuits with negative or positive potential.

The types 9004/5... with electronic voltage limitation enabling the application of unregulated power supplies.



Technical Data	
Certificates	<p><b>Europe (CENELEC)</b> PTB 02 ATEX 2088 PTB 02 ATEX 2009 (Installation in Zone 2)</p> <p><b>USA</b> FM Approval 3017163</p> <p><b>Canada</b> CSA 1497596 (LR 43394)</p> <p><b>Russia</b> CTB 04.B00144</p> <p><b>Ukraine</b> ISCVE</p>
Explosion protection	<p><b>Europe (CENELEC)</b> ⊕ II (2) GD [EEx ib] IIB/IIC ⊕ II 3 G EEx nA II T4 (Installation in Zone 2)</p> <p><b>USA</b> I.S. circuits for: Class I, II, III, Division 1, Groups A, B, C, D, E, F, G I.S. circuits for: Class I, Zone 1, Group IIC I.S. circuits for: Class I, II, III, Division 1, Groups C, D, E, F, G I.S. circuits for: Class I, Zone 1, Group IIB Class I, Division 2, Groups A, B, C, D Class I, Zone 2, Group IIC</p> <p><b>Canada</b> I.S. circuits for: Class I, Groups A, B, C, D; Class II, Groups E, F, G; Class III Class I, Zone 2, Groups IIC/IIB</p>
Installation	in Zone 2, Division 2 and in safe area
Enclosure material	Polyamide 6 GF
Type of protection	according to IEC 60529  terminal enclosure: IP 20 housing: IP 40
Connection	4 cage terminals, each maximum 1.5 mm <sup>2</sup> flexible / solid 2 PA-terminals, each maximum 4 mm <sup>2</sup> flexible / solid
Ambient temperature	- 20 °C ... + 60 °C
Storage	- 20 °C ... + 75 °C
Maximum relative humidity	95 % mean, no dewing
Leakage current at U <sub>N</sub>	≤ 2 µA (if not stated otherwise)
Temperature effect	≤ 0.25 % / 10 K
Frequency	≤ 10 kHz
Weight	approx. 0.115 kg

**Selection Table**

Version	Description	Type	Page
Single-channel barriers	<ul style="list-style-type: none"><li>• For positive potential</li><li>• Electronic current limitation</li><li>• Grounded circuit</li></ul>	9004/01	4
	<ul style="list-style-type: none"><li>• For positive potential</li><li>• Electronic current limitation</li><li>• Voltage limitation</li><li>• Grounded circuit</li></ul>	9004/51	5
	<ul style="list-style-type: none"><li>• For negative potential</li><li>• Electronic current limitation</li><li>• Grounded circuit</li></ul>	9004/00	6
	<ul style="list-style-type: none"><li>• For negative potential</li><li>• Electronic current limitation</li><li>• Voltage limitation</li><li>• Grounded circuit</li></ul>	9004/50	7

**Single-Channel Safety Barriers with Electronic Current Limitation for Positive Polarity**

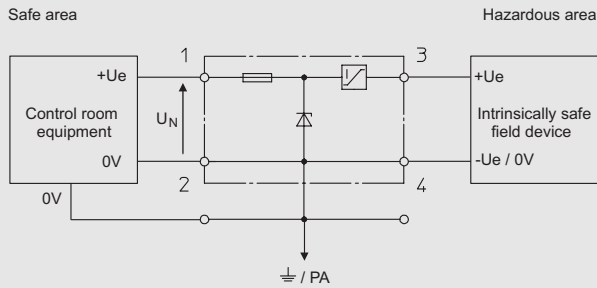

- For positive potential
- Electronic current limitation
- Grounded circuit
- Approved for installation in Division 2 and Zone 2

05853E02

**Selection Table**

U <sub>N</sub>	R <sub>min</sub>	R <sub>max</sub>	I <sub>max</sub>	ΔU	Safety values								Order number
					U <sub>o</sub>	I <sub>o</sub>	P <sub>o</sub>	IIC L <sub>o</sub>	C <sub>o</sub>	IIB L <sub>o</sub>	C <sub>o</sub>		
V	Ω	Ω	mA	V	V	mA	mW	mH	μF	mH	μF		
12	26	30	40	0.9	16.8	50	840	0.86	0.16	2.5	1.2	<b>9004/01-168-050-001</b>	
12	20	24	80	0.9	16.8	100	1680	--	--	1.6	1.1	<b>9004/01-168-100-001</b>	
16	34	44	40	0.9	20	50	1000	--	--	2.5	0.68	<b>9004/01-200-050-001</b>	
20	48	53	40	0.9	26.3	50	1315	--	--	1.3	0.33	<b>9004/01-263-050-001</b>	
24	60	68	20	0.9	28	25	700	--	--	2.5	0.28	<b>9004/01-280-025-001</b>	
24	50	56	35	0.9	28	45	1260	--	--	1.5	0.28	<b>9004/01-280-045-001</b>	
26	67	73	20	0.9	31.5	25	787.5	--	--	2.5	0.23	<b>9004/01-315-025-001</b>	

**Functional and Maximum Safety Values**

U <sub>N</sub>	Nominal voltage	ΔU	Additional voltage drop through the safety barrier	L <sub>o</sub>	Maximum permissible external inductance
R <sub>min</sub>	Minimum resistance of the safety barrier	U <sub>o</sub>	Maximum voltage	C <sub>o</sub>	Maximum permissible external capacity
R <sub>max</sub>	Maximum resistance of the safety barrier	I <sub>o</sub>	Maximum current		
I <sub>max</sub>	Maximum current through the safety barrier	P <sub>o</sub>	Maximum power		



### Single-Channel Safety Barriers with Electronic Current Limitation for Positive Polarity with Voltage Limitation

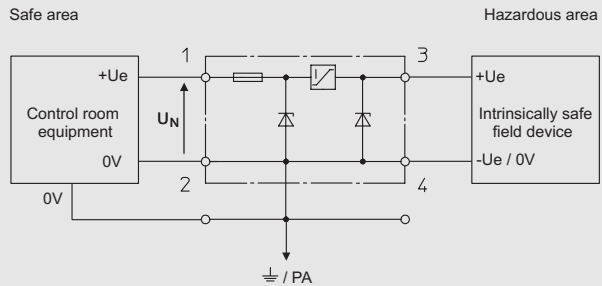

- For positive potential
- Electronic current limitation
- Voltage limitation
- Grounded circuit
- Approved for installation in Division 2 and Zone 2

05866E01

#### Selection Table

U <sub>N</sub>	I <sub>max</sub>	Safety values								Order number
		U <sub>o</sub>	I <sub>o</sub>	P <sub>o</sub>	IIC		IIB			
V	mA	V	mA	mW	L <sub>o</sub> mH	C <sub>o</sub> μF	L <sub>o</sub> mH	C <sub>o</sub> μF		
23 ... 27	40	20.6	50	1030	--	--	2.5	0.58	9004/51-206-050-001 *)	
23 ... 27	70	20.6	85	1751	--	--	0.37	0.68	9004/51-206-085-001 *)	
24 ... 26	25	22	30	660	1.3	0.073	2.5	0.55	9004/51-220-030-001 **)	

\*) Maximum leakage current < 2 mA; maximum output voltage 17 V

\*\*) Maximum leakage current < 2 mA; maximum output voltage 18 V

#### Functional and Maximum Safety Values

U <sub>N</sub>	Nominal voltage	U <sub>o</sub>	Maximum voltage	L <sub>o</sub>	Maximum permissible external inductance
I <sub>max</sub>	Maximum current through the safety barrier	I <sub>o</sub>	Maximum current	C <sub>o</sub>	Maximum permissible external capacity
ΔU	Additional voltage drop through the safety barrier	P <sub>o</sub>	Maximum power		

**Single-Channel Safety Barriers with Electronic Current Limitation for Negative Polarity**

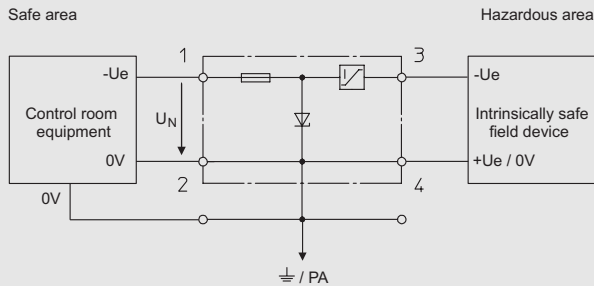

- For negative potential
- Electronic current limitation
- Grounded circuit
- Approved for installation in Division 2 and Zone 2

**Selection Table**

U <sub>N</sub>	R <sub>min</sub>	R <sub>max</sub>	I <sub>max</sub>	ΔU	Safety values								Order number
					U <sub>o</sub>	I <sub>o</sub>	P <sub>o</sub>	IIC L <sub>o</sub>	C <sub>o</sub>	IIB L <sub>o</sub>	C <sub>o</sub>		
V	Ω	Ω	mA	V	V	mA	mW	mH	μF	mH	μF		
12	26	30	40	0.9	16.8	50	840	0.86	0.16	2.5	1.2	<b>9004/00-168-050-001</b>	
12	20	24	80	0.9	16.8	100	1680	--	--	1.6	1.1	<b>9004/00-168-100-001</b>	
16	34	44	40	0.9	20	50	1000	--	--	2.5	0.68	<b>9004/00-200-050-001</b>	
20	48	53	40	0.9	26.3	50	1315	--	--	1.3	0.33	<b>9004/00-263-050-001</b>	
24	60	68	20	0.9	28	25	700	--	--	2.5	0.28	<b>9004/00-280-025-001</b>	
24	50	56	35	0.9	28	45	1260	--	--	1.5	0.28	<b>9004/00-280-045-001</b>	
26	67	73	20	0.9	31.5	25	787.5	--	--	2.5	0.23	<b>9004/00-315-025-001</b>	

**Functional and Maximum Safety Values**

U <sub>N</sub>	Nominal voltage	ΔU	Additional voltage drop through the safety barrier	L <sub>o</sub>	Maximum permissible external inductance
R <sub>min</sub>	Minimum resistance of the safety barrier	U <sub>o</sub>	Maximum voltage	C <sub>o</sub>	Maximum permissible external capacity
R <sub>max</sub>	Maximum resistance of the safety barrier	I <sub>o</sub>	Maximum current		
I <sub>max</sub>	Maximum current through the safety barrier	P <sub>o</sub>	Maximum power		



### Single-Channel Safety Barriers with Electronic Current Limitation for Negative Polarity with Voltage Limitation

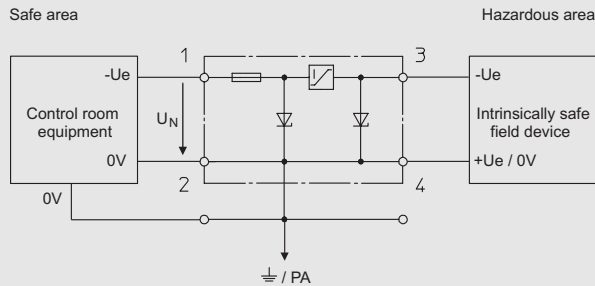

- For negative potential
- Electronic current limitation
- Voltage limitation
- Grounded circuit
- Approved for installation in Division 2 and Zone 2

05852E02

#### Selection Table

U <sub>N</sub>	I <sub>max</sub>	Safety values								Order number
		U <sub>o</sub>	I <sub>o</sub>	P <sub>o</sub>	IIC	IIB	L <sub>o</sub>	C <sub>o</sub>		
V	mA	V	mA	mW	L <sub>o</sub> mH	C <sub>o</sub> μF	L <sub>o</sub> mH	C <sub>o</sub> μF		
23 ... 27	40	20.6	50	1030	--	--	2.5	0.58	9004/50-206-050-001 <sup>*)</sup>	
23 ... 27	70	20.6	85	1751	--	--	0.37	0.68	9004/50-206-085-001 <sup>*)</sup>	
24 ... 26	25	22	30	660	1.3	0.073	2.5	0.55	9004/50-220-030-001 <sup>**)</sup>	



<sup>\*)</sup> Maximum leakage current < 2 mA; maximum output voltage 17 V

<sup>\*\*)</sup> Maximum leakage current < 2 mA; maximum output voltage 18 V

#### Functional and Maximum Safety Values

U <sub>N</sub>	Nominal voltage	U <sub>o</sub>	Maximum voltage	L <sub>o</sub>	Maximum permissible external inductance
I <sub>max</sub>	Maximum current through the safety barrier	I <sub>o</sub>	Maximum current	C <sub>o</sub>	Maximum permissible external capacity
ΔU	Additional voltage drop through the safety barrier	P <sub>o</sub>	Maximum power		

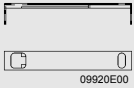
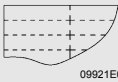
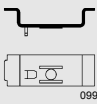
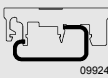

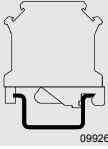
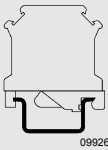
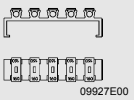
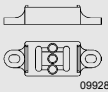
<b>Accessories and Spare Parts</b>				
Designation	Illustration	Description	Order number	Weight kg
Back-up fuse	 09919E00	for all safety barriers Series 9001, 9002 and 9004 unit: 5 pcs.	<b>158964</b>	0.008
Holder for labels	 09920E00		<b>158977</b>	0.002
Labelling paper	 09921E00	perforated, for typing Format: DIN A4	<b>158973</b>	0.005
Adaptor	 09922E00		<b>158826</b>	0.006
Mounting attachment moulded plastic	 09924E00		<b>165283</b>	0.004
DIN rail	 07104E00	NS 35 / 15 (meter length)	<b>103714</b>	1.410
Earth terminal	 09926E00	USLKG 5 (wire range $\leq 4 \text{ mm}^2$ )	<b>112760</b>	0.012
Earth terminal	 09926E00	USLKG 6 N (wire range $\leq 6 \text{ mm}^2$ )	<b>112599</b>	0.030
Fuse holder	 09927E00		<b>158834</b>	0.020
Insulating stand off	 09928E00	for rail NS 35/15	<b>158828</b>	0.023



**Dimensional Drawings** (All Dimensions in mm) - Subject to Alterations

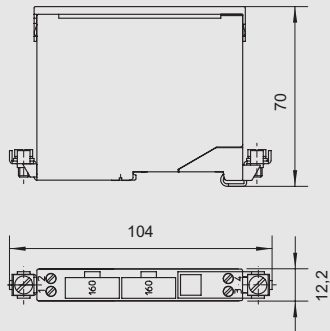

09929E00

**Safety barriers 9001, 9002, 9004**

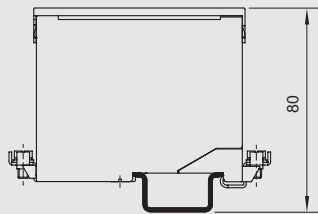

09930E00

**Safety barriers 9001, 9002, 9004**  
mounting on  
DIN rail NS 35/15 (acc. to EN 50 022)

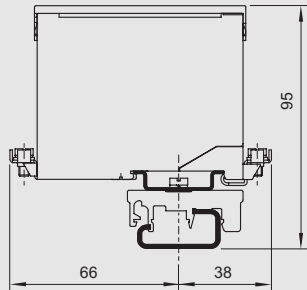

09932E00

**Safety barriers 9001, 9002, 9004**  
mounting on  
DIN rail NS 32 (acc. to EN 50 035)  
by means of adaptor and  
mounting attachment, moulded plastic

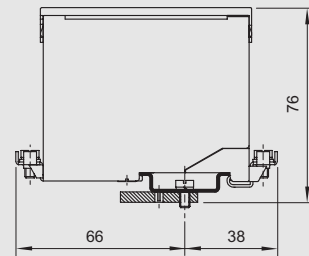

09933E00

**Safety barriers 9001, 9002, 9004**  
mounting on  
mounting plate by means of adaptor



We reserve the right to make alterations to the technical data, weights, dimensions, designs and products available without notice. The illustrations cannot be considered binding.