



GasAlertMicroClip

H₂S, CO, O₂, Combustibles

1, 2, 3, and 4 Gas Detectors

User Manual



Limited Warranty & Limitation of Liability

BW Technologies LP (BW) warrants this product to be free from defects in material and workmanship under normal use and service for a period of two years, beginning on the date of shipment to the buyer. This warranty extends only to the sale of new and unused products to the original buyer. BW's warranty obligation is limited, at BW's option, to refund of the purchase price, repair, or replacement of a defective product that is returned to a BW authorized service center within the warranty period. In no event shall BW's liability hereunder exceed the purchase price actually paid by the buyer for the Product.

This warranty does not include:

- a) fuses, disposable batteries or the routine replacement of parts due to the normal wear and tear of the product arising from use;
- b) any product which in BW's opinion, has been misused, altered, neglected or damaged by accident or abnormal conditions of operation, handling or use;
- c) any damage or defects attributable to repair of the product by any person other than an authorized dealer, or the installation of unapproved parts on the product; or

The obligations set forth in this warranty are conditional on:

- a) proper storage, installation, calibration, use, maintenance and compliance with the product manual instructions and any other applicable recommendations of BW;
- b) the buyer promptly notifying BW of any defect and, if required, promptly making the product available for correction. No goods shall be returned to BW until receipt by the buyer of shipping instructions from BW; and
- c) the right of BW to require that the buyer provide proof of purchase such as the original invoice, bill of sale or packing slip to establish that the product is within the warranty period.

THE BUYER AGREES THAT THIS WARRANTY IS THE BUYER'S SOLE AND EXCLUSIVE REMEDY AND IS IN LIEU OF ALL OTHER WARRANTIES, EXPRESS OR IMPLIED, INCLUDING BUT NOT LIMITED TO ANY IMPLIED WARRANTY OF MERCHANTABILITY OR FITNESS FOR A PARTICULAR PURPOSE. BW SHALL NOT BE LIABLE FOR ANY SPECIAL, INDIRECT, INCIDENTAL OR CONSEQUENTIAL DAMAGES OR LOSSES, INCLUDING LOSS OF DATA, WHETHER ARISING FROM BREACH OF WARRANTY OR BASED ON CONTRACT, TORT OR RELIANCE OR ANY OTHER THEORY.

Since some countries or states do not allow limitation of the term of an implied warranty, or exclusion or limitation of incidental or consequential damages, the limitations and exclusions of this warranty may not apply to every buyer. If any provision of this warranty is held invalid or unenforceable by a court of competent jurisdiction, such holding will not affect the validity or enforceability of any other provision.

BW Technologies by Honeywell
Corporate Headquarters
2840 – 2nd Ave. SE
Calgary, AB
Canada T2A 7X9

BW Technologies by Honeywell
America
3279 West Pioneer Parkway
Arlington, TX
USA 76013

BW Technologies by Honeywell
Europe
5 Canada Close
Banbury, Oxfordshire
UK OX16 2RT

Table of Contents

Title	Page
Introduction.....	1
Contacting BW Technologies by Honeywell	2
Safety Information - Read First	2
Getting Started	6
Activating the Detector	10
Self-Test	10
Self-Test Pass	15
Self-Test Fail	15
Battery Test	15
Backlight	16
Deactivating the Detector.....	16
Options	16
Detector Identification.....	17
Sensor Options.....	17
User Options Menu	20
Language Menu.....	21
Alarms	22
Computed Gas Exposures	24
Viewing Gas Exposures	25
Gas Alarm Setpoints	26
Resetting Gas Alarm Setpoints	26
Stopping a Gas Alarm	27
Sensor Alarm.....	27

Title	Page
Low Battery Alarm	27
Automatic Shutdown Alarm	27
Calibration	28
Guidelines	28
Diagnostics Protection	29
Applying Gas to the Sensors	29
Calibration Procedure	30
Datalogs	34
Event Logs	34
Downloading Datalogs and Event Logs	34
Maintenance	34
Charging the Detector	35
Replacing a Sensor or Sensor Filter	36
Troubleshooting	39
Replacement Parts and Accessories	42
Specifications	43
General Datalogger Specifications	45

List of Tables

Table	Title	Page
1.	Gases Monitored	1
2.	International Symbols	5
3.	GasAlertMicroClip Detector	7
4.	Display Elements	8
5.	Pushbutton	9
6.	Alarms	22
7.	Computed Gas Exposures	24
8.	Gas Alarm Setpoints	26
9.	Sample Factory Alarm Setpoints	26
10.	Applying Gas to the Sensors	29
11.	Replacing a Sensor or Sensor Filter	37
12.	Troubleshooting Tips	39
13.	Replacement Parts and Accessories	42

List of Figures

Figure Title	Page
1. GasAlertMicroClip Detector	7
2. Display Elements	8
3. Applying Gas to the Sensors	29
4. Connecting the Charging Adapter	35
5. Replacing a Sensor or Sensor Filter	36
6. Replacing the Rear Shell	38

CAUTION: FOR SAFETY REASONS, THIS EQUIPMENT MUST BE OPERATED AND SERVICED BY QUALIFIED PERSONNEL ONLY. READ AND UNDERSTAND INSTRUCTION MANUAL COMPLETELY BEFORE OPERATING OR SERVICING.

GasAlertMicroClip Multi-Gas Detector with User Downloadable Datalogger and Event Log

Standard instrument is equipped with integral concussion-proof boot, internal vibrator alarm, and provides full-time continuous datalogging while the instrument is operating. Data is saved to memory and can be downloaded by the user via an IR device to a PC. Data is imported into standard office software (Microsoft® Excel, Access, etc.). Wraparound memory ensures the most recent data is always saved.

GasAlertMicroClip

Introduction

Warning

To ensure your personal safety, read “Safety Information” before you use the detector.

The GasAlertMicroClip gas detector (“the detector”) warns of hazardous gas at levels above user-selectable alarm setpoints.

The detector is a personal safety device. It is your responsibility to respond properly to the alarm.

Table 1 lists the gases monitored.

Table 1. Gases Monitored

Gas Detected	Unit of Measure
Hydrogen sulfide (H ₂ S)	parts per million (ppm)
Carbon monoxide (CO)	parts per million (ppm)
Oxygen (O ₂)	percent by volume (%)
Combustible gases (LEL) Field selectable for:	a) percent of lower explosive limit (% LEL) b) percent by volume methane 0-5.0% v/v

Contacting BW Technologies by Honeywell

To contact BW Technologies by Honeywell, call:

USA: 1-888-749-8878

Canada: 1-800-663-4164

Europe: +44 (0) 1295 700300

Other countries: +1-403-248-9226

Address correspondence to:

BW Technologies by Honeywell

Corporate office

2840 – 2 Avenue S.E.

Calgary, AB T2A 7X9

CANADA

Email us at: info@bwt.net

Visit BW Technologies by Honeywell's web site at:

www.gasmonitors.com

ISO 9001

Safety Information - Read First

Use the detector only as specified in this manual, otherwise the protection provided by the detector may be impaired.

International symbols used on the detector and in this manual are explained in Table 2.

Read the **Cautions** on the following pages before using the detector.



This instrument contains a lithium polymer battery. Do not mix with the solid waste stream. Spent batteries should be disposed of by a qualified recycler or hazardous materials handler.



⚠ Cautions

- ⇒ **Warning:** Substitution of components may impair Intrinsic Safety.
- ⇒ **Caution:** For safety reasons, this equipment must be operated and serviced by qualified personnel only. Read and understand the user manual completely before operating or servicing.
- ⇒ Do not use the detector if it is damaged. Before you use the detector, inspect the case. Look for cracks or missing parts.
- ⇒ If the detector is damaged or something is missing, contact [BW Technologies by Honeywell](#) immediately.
- ⇒ Use only sensor(s) specifically designed for your GasAlertMicroClip model. (See the section, [Replacement Parts and Accessories](#)).
- ⇒ Calibrate the detector before first-time use and then on a regular schedule, depending on use and sensor exposure to poisons and contaminants. BW recommends at least once every 180 days (6 months).
- ⇒ BW recommends to “bump test” the sensors, before each day’s use, to confirm their ability to respond to gas by exposing the detector to a gas concentration that exceeds the alarm setpoints. Manually verify that the audible and visual alarms are activated. Calibrate if the readings are not within the specified limits.
- ⇒ It is recommended that the combustible sensor be checked with a known concentration of calibration gas after any known exposure to catalyst contaminants/poisons (sulfur compounds, silicon vapors, halogenated compounds, etc).
- ⇒ The combustible sensor is factory calibrated to 50% LEL methane. If monitoring a different combustible gas in the % LEL range, calibrate the sensor using the appropriate gas.
- ⇒ **Caution:** High off-scale readings may indicate an explosive concentration.
- ⇒ Only the combustible gas detection portion of this instrument has been assessed for performance by CSA International.

⚠ Cautions

- ⇒ **Protect the combustible sensor from exposure to lead compounds, silicones, and chlorinated hydrocarbons. Although certain organic vapors (such as leaded gasoline and halogenated hydrocarbons) may temporarily inhibit sensor performance, in most cases, the sensor will recover after calibration.**
- ⇒ **For use only in potentially explosive atmospheres where oxygen concentrations do not exceed 20.9% (v/v).**
- ⇒ **Any rapid up-scaling reading followed by a declining or erratic reading may indicate a gas concentration beyond upper scale limit, which may be hazardous.**
- ⇒ **Calibrate only in a safe area that is free of hazardous gas.**
- ⇒ **Use only BW approved batteries for your GasAlertMicroClip model (see [Specifications](#)).**
- ⇒ **Charge the detector before first-time use. BW recommends the detector be charged after every workday.**
- ⇒ **Charge the GasAlertMicroClip using the recommended charging adapter only. Do not use any other charging adapter. Failure to observe this precaution could lead to fire or explosion.**
- ⇒ **Extended exposure of the GasAlertMicroClip to certain concentrations of combustible gases and air may stress a detector element, which can seriously affect its performance. If an alarm occurs due to high concentration of combustible gases, recalibration should be performed, or if needed, the sensor replaced.**
- ⇒ **Do not test the combustible sensor's response with a butane cigarette lighter; doing so will damage the sensor.**
- ⇒ **Do not expose the detector to electrical shock and/or severe continuous mechanical shock.**
- ⇒ **Do not attempt to disassemble, adjust, or service the detector unless instructions for that procedure are contained in the manual and/or that part is listed as a replacement part. Use only BW Technologies by Honeywell [replacement parts](#).**
- ⇒ **The detector warranty will be voided if customer, personnel, or third parties damage the detector during repair attempts. Non-BW Technologies by Honeywell repair/service attempts void this warranty.**

Table 2. International Symbols

Symbol	Meaning
	Approved to both U.S. and Canadian Standards by CSA - International
	European Explosives Protection
	Conforms to European Union Directives
ATEX	Conforms to European ATEX Directives
IECEx	International Electrotechnical Commission Scheme for Certification to Standards for Electrical Equipment for Explosive Atmospheres

Getting Started

The list below provides the standard items included with your detector. If the detector is damaged or something is missing, contact the place of purchase immediately.

- Sensors: H₂S, CO, O₂, and combustible (LEL);
- Calibration hose and cap;
- Charging adapter;
- Quick reference guide;
- Quick reference operations key; and
- CD.

To order replacement parts, see the section [Replacement Parts and Accessories](#).

The detector comes with sensors and rechargeable battery installed. If the battery needs to be replaced, contact [BW Technologies by Honeywell](#). If any of the sensors or the sensor filter needs to be replaced, refer to [Replacing a Sensor or Sensor Filter](#).

To become familiar with the features and functions of the detector, study the following figures and tables:

- Figure 1 and Table 3 describes the detector's components.
- Figure 2 and Table 4 describes the detector's display elements.
- Table 5 describes the detector's pushbutton.

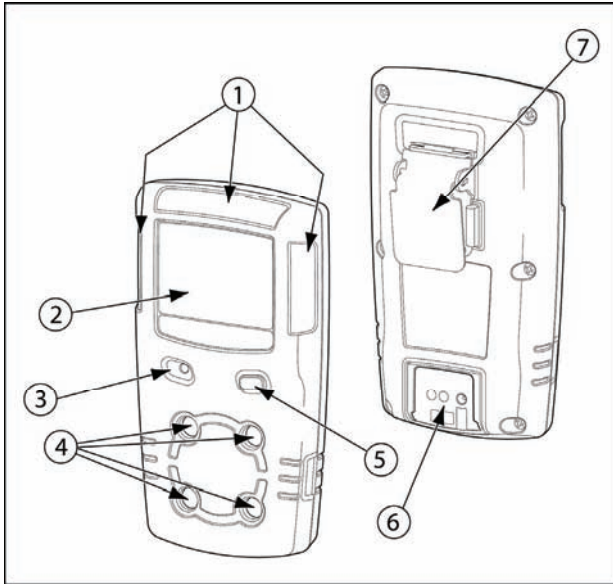

Figure 1. Parts of the GasAlertMicroClip

Table 3. Parts of the GasAlertMicroClip

Item	Description
1	Visual alarm bars (LED)
2	Liquid crystal display (LCD)
3	Audible alarm
4	Sensors
5	Pushbutton
6	Charging connector / IR interface
7	Alligator clip

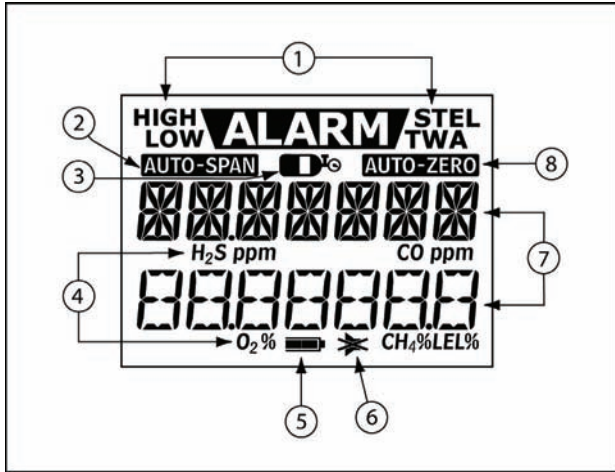



Figure 2. Display Elements

Table 4. Display Elements

Item	Description
1	Alarm condition
2	Automatically span sensor
3	Gas cylinder
4	Gas identifier bars
5	Battery life indicator
6	Stealth mode
7	Numeric value
8	Automatically zero sensor

Table 5. Pushbutton

Pushbutton	Description
	<ul style="list-style-type: none"> • To activate the detector press ○. • To deactivate the detector, press and hold ○ until the OFF countdown is complete and the LCD deactivates. • To view the TWA, STEL, and maximum (MAX) hold readings, press ○ twice. To clear the TWA, STEL, and MAX readings, press ○ when the LCD displays RESET. • To initiate calibration, press and hold ○ as the detector executes the OFF countdown and continue to hold ○ as the LCD briefly turns off and then executes the CAL countdown. Release ○ once the CAL countdown is complete. • To activate the backlight, press ○. • To acknowledge latched alarms, press ○. • To acknowledge a low alarm and disable the beeper, press ○ (if Low Alarm Acknowledge user option is enabled).

Activating the Detector

To activate the detector, press  in a normal clean atmosphere.

Self-Test

Once the detector is activated, it performs the following checks. Manually verify that all actions occur.

Battery Test

The detector administers a battery test during start-up. If the battery has insufficient power to start up, the liquid crystal display (LCD) displays the following screen before the detector deactivates.



Recharge the battery for 2-3 hours before restarting the detector (see [Charging the Detector](#)).

Audible/Visual Test

1. The LCD shows all the display elements as it beeps, flashes, vibrates, and briefly turns on the backlight.

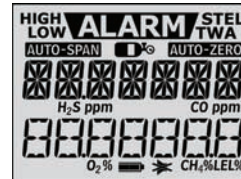

Detector Version

2. The version number of the detector is then displays on the LCD.



Note

Users can enter a 2-line message, up to a maximum of 25 characters per line. The message appears on the LCD after the detector version displays. This option is disabled in the factory settings. The message can be enabled or changed in the Sensors tab in Soft Tools. See [GasAlertMicroClip Soft Tools](#) instruction sheet.

Alarm Setpoints

- Next, the LCD shows the TWA, STEL, low, and high alarm setpoints.

Note

The alarm setpoints on a shipped detector may vary by region. See [Resetting Gas Alarm Setpoints](#).

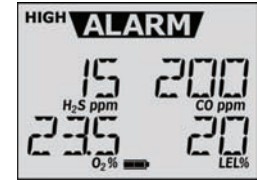
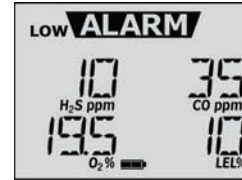
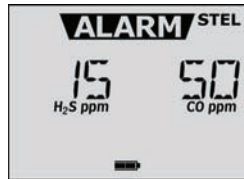
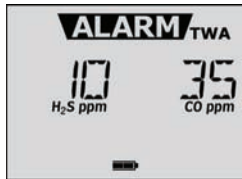

Sensors and Power Test

- The detector then tests the sensors.



A screen then appears confirming that the test was successful (**TEST OK**) or which sensor(s) failed the test (e.g., **ERROR H2S**) before continuing with the self-test.



Note

The sensors are continuously tested while the detector is activated.

Automatic Zero and O₂ Calibration (optional)

5. The sensors (H₂S, CO, and LEL) are automatically zeroed and the O₂ sensor is automatically calibrated (unless it is disabled in the detector's options). The detector beeps twice to signal a successful zero and span.

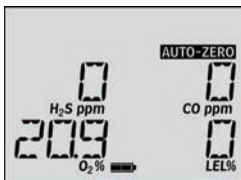

If only the automatic oxygen calibration is enabled on the detector, the following screen appears.



Note

If ambient air is set to be measured 20.8% vol., the automatic oxygen calibration screen displays **20.8** instead of 20.9.

Calibration Due Date (optional)

6. The LCD displays the number of days remaining until the next calibration is due.



Note

If the [calibration interval](#) is set to 0, then the calibration due date start-up feature is bypassed.

If any sensor is past its calibration due date, the detector displays **CAL DUE today** as the detector beeps, flashes, and vibrates.



Press to acknowledge the warning and enter normal operation, or continue with the self-test if applicable.

Forced Calibration Enabled

If forced calibration is enabled (refer to [Force Calibration When Overdue](#)) and a sensor is past its calibration due date, calibration is mandatory before the detector can enter normal operation.



If is pressed, the detector launches the calibration procedure (refer to [Calibration](#)). If is not pressed within 2 minutes, the detector deactivates.

Note

Calibration can also be performed by using BW Technologies by Honeywell's MicroDock II.

Cal Lock Enabled

If the **Cal Lock** option is enabled, an infrared (IR) device is required to calibrate the detector.

IR--LOCK displays as the detector tries to establish a connection with an IR device (e.g., BW Technologies by Honeywell's MicroDock II or IR Link adapter).



Once IR communication has been established, the calibration procedure is executed. If IR communication is not established within 2 minutes or is pressed, the detector deactivates.

Bump Check (optional)

Note

Bump check is not performed if the detector was just calibrated (step #6).

BW recommends to “bump check” the sensors, before each day’s use, to confirm their ability to respond to gas by exposing the detector to a gas concentration that exceeds the alarm setpoints.

If the [bump interval](#) is set to 0, the bump check start-up feature is bypassed.

7. If bump check is enabled and the bump checks have passed, or none of the sensors are due for a bump check, a warning screen displays the number of days remaining until a bump check needs to be performed.



If any of the sensors need to be bump checked, the detector displays the following screen:



If force bump or is not enabled, press to enter normal operation.

Note

***BUMPCHK todAY** also displays if a bump check was executed but failed.*

Force Bump Enabled

If force bump is enabled, (refer to [Force Bump When Overdue](#)) and a sensor is past its bump interval, a bump check is mandatory before the detector can enter normal operation.

While the LCD displays **BUMPCHK todAY**, apply gas to the detector or press \bigcirc to deactivate the detector. If gas is applied to the detector, the detector needs to enter alarm for the bump check to be accepted. Once the bump check has been accepted, the detector enters normal operation.

Bump Check Successful

If the bump check is successful, the detector enters normal operation. The detector remains in alarm until the bump gas dissipates. Verify that the audible and visual alarms are functioning properly (refer to [Alarms](#)).

Self-Test Pass

If the detector passes the self-test, the detector begins normal operation. The LCD displays the ambient gas readings.

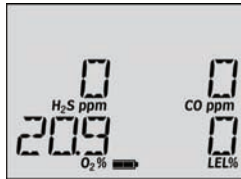

The detector starts recording the maximum gas exposure (MAX) and calculating the short-term exposure level (STEL) and time-weighted average (TWA) exposures.

Self-Test Fail

Once the detector enters normal operation, the LCD displays which sensor has failed the self-test by displaying **Err** above the target gas bar. (Refer to the [Troubleshooting](#) section.)



Battery Test

The battery is tested on activation and continuously thereafter. A newly charged battery should operate for 10-12 hours typically before automatically shutting down. The battery power is continually displayed during normal operation. If the battery power is low,  flashes as the detector emits one beep and one flash (LED) every 5 seconds.

Note

If the confidence beep is enabled, the audible alarm beeps if the battery has sufficient power and stops if the battery power is low. See the section, [Confidence Beep](#).

Backlight

The LCD's backlight automatically activates when there is an alarm condition. Pressing  activates the backlight in any condition.

Deactivating the Detector

To deactivate the detector, press and hold  while it beeps and flashes to the corresponding countdown.



At the end of the countdown, the detector emits one short beep before completely deactivating.

Note

If  is released before the countdown is complete, the detector will not deactivate.

Options

To access the user options, connect the detector to the IR Link adapter and use the GasAlertMicroClip Soft Tools software. Refer to the *GasAlertMicroClip Soft Tools* manual for complete instructions.

The following are the available user options in Soft Tools:

1. **Detector Identification:** Start-up message;
2. **Carbon Monoxide (CO), Hydrogen Sulphide (H₂S), Oxygen (O₂), and Combustible/LEL:** sensor disabled, calibration gas concentration, calibration interval, bump interval, low alarm, high alarm, TWA alarm, STEL alarm, STEL interval, auto-zero on start-up, O₂ auto-calibration on start-up, and LEL by vol CH₄;
3. **User Options:** confidence beep, latching alarms, safe mode, stealth mode, IR stealth mode, low alarm acknowledge, force calibration when overdue, calibration lock, force bump when overdue,
4. **Language:** English, French (**Français**), German (**Deutsch**), Spanish (**Español**), and Portuguese (**Português**).

Detector Identification

Start-up Message

This option allows you to personalize your detector. In the Detector Identification group there are two fields available for you to enter a message:

Startup Message Top Line; and

Startup Message Bottom Line.

If a message is entered, it appears during the start-up sequence after the detector version is displayed. The message either

- a) displays on the LCD for 3 seconds (if the entire message fits on the LCD); or
- b) scrolls by twice on the LCD.

Sensor Options

The sensor options tab allows you to change the factory settings for the H₂S, CO, O₂, and LEL sensors.

Sensor Disabled

⚠ Warning

Disabling an installed sensor configures the detector to a 1, 2, or 3-gas unit. No protection is now provided for the gas targeted by that sensor(s). Disabling a sensor should be performed with extreme caution.

Use the **Disabled** function to disable a sensor. If a sensor is disabled, it can no longer be viewed on the LCD during normal operation. All sensors are enabled upon shipment. If a sensor is disabled, it may be enabled again at any time

If a sensor fails, disabling the sensor deactivates the sensor alarm (refer to [Alarms](#)). The sensor should be replaced and enabled as soon as possible (see [Replacing a Sensor or Sensor Filter](#)).

The detector functions normally with the remaining enabled sensors.

Calibration Gas Concentration

The calibration span gas option (**Cal Gas**) allows you to input a new gas concentration for each sensor. Refer to the values listed on your calibration gas cylinder.

Note

BW recommends that the calibration concentration value be set between specific ranges. Refer to the [Calibration](#) section.

Calibration Interval

The calibration interval (**Cal Interval**) allows you to choose the number of days before the next calibration should be performed. You can select the minimum number of days (1 day) to the maximum number of days (365 days) before the next calibration. A different calibration interval can be selected for each sensor. Select **0** to disable the calibration interval. The detector is shipped with a default of 180 days.

Note

BW recommends that the detector be calibrated once every 180 days (6 months).

Bump Interval

The **Bump Interval** determines the number of days before a sensor needs to be bump checked. A different interval value can be selected for each sensor. Set the interval value to **0** to disable this option. This option is disabled upon shipment.

Note

BW recommends to “bump check” the sensors, before each day’s use, to confirm their ability to respond to gas by exposing the detector to a gas concentration that exceeds the alarm setpoints.

Low Alarm

Low Alarm option allows you to change the low alarm setpoint for each of the sensors. Refer to [Resetting Gas Alarm Setpoints](#) for the factory alarm setpoints.

High Alarm

High Alarm option changes the high alarm setpoint for each of the sensors. Refer to [Resetting Gas Alarm Setpoints](#) for the factory alarm setpoints.

TWA Alarm

The **TWA Alarm** option allows you to select the time-weighted average (TWA) alarm setpoint for either the H₂S or CO sensor. Refer to [Resetting Gas Alarm Setpoints](#) for the factory alarm setpoints.

STEL Alarm

The **STEL Alarm** option changes the short-term exposure limit (STEL) alarm setpoint for either the H₂S or CO sensor. Refer to [Resetting Gas Alarm Setpoints](#) for the factory alarm setpoints.

STEL Interval

The STEL interval determines the rate at which STEL is calculated. The detector is shipped with the **STEL Interval** set to 15 minutes. This value can be adjusted between 5 and 15 minutes.

Auto Zero on Start-up

When enabled this option (**CO/H2S/LEL Auto-Zero on Startup**) allows the detector to auto zero the chosen sensor during activation. The auto zero option for each sensor is disabled upon shipment.

Automatic O₂ Calibration

When the **O₂ Auto-Calibration on Startup** option is enabled, it forces the detector to automatically calibrate the oxygen sensor upon activating the detector. The automatic calibration option is enabled upon shipment.

LEL By Vol CH₄

The **LEL By Vol CH₄** option is only applicable to the LEL sensor. If it is enabled, it shows the LEL reading in %vol. assuming a methane environment.

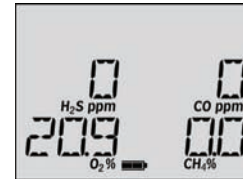

User Options Menu

Confidence Beep

The **Confidence Beep** notifies that the detector is on and the battery has sufficient power to respond to a hazardous level of gas to emit an alarm. Instead of beeping when the battery power is low, the audible alarm beeps once every 10 seconds to advise that the battery has sufficient power. The confidence beep stops when the battery power is low. This option is disabled upon shipment.

Latching Alarms

The detector is shipped with the **Latching Alarm** function disabled. If the low and high gas alarms are set to latch, the audible, visual, and vibrator alarms persist during an alarm. The alarm deactivates when it is acknowledged by pressing and the alarm condition is no longer present.

Safe Mode

When enabled, the **Safe Mode** function advises that normal ambient conditions prevail and no monitored gas hazard exist. **SAFE** is constantly displayed when all gas levels are normal or below the alarm setpoints.



The safe mode option is disabled upon shipment.

Stealth Mode

The detector is shipped with **Stealth Mode** disabled. When it is activated, stealth mode disables the beepers, backlight, and alarm LEDs and  is constantly displayed on the LCD.

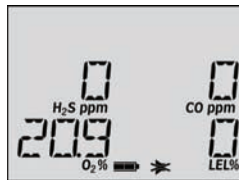

IR Stealth Mode

If the **IR Stealth Mode** option is enabled, it disables the audible alarm and the backlight. The vibrator and the IR LEDs are enabled and  is constantly displayed on the LCD.

Low Alarm Acknowledge

When **Low Alarm Acknowledge** is enabled, the audible alarm can be disabled during a low alarm if  is pressed, but the vibrator and alarm LEDs continue to be enabled. This option is not applicable to the O₂ sensor.

Force Calibration When Overdue

Enabling the **Force Calibration When Overdue** option forces the detector to enter the calibration process if a sensor is overdue for calibration upon start-up. If the detector is not calibrated immediately, the detector will deactivate. The detector is shipped with this option disabled.

Cal Lock

If **Cal Lock** is enabled, calibration can only be completed with an IR device like Soft Tools or the MicroDock II Base Station. Though **Cal Lock** is enabled, the detector will still perform an auto zero when activated. The cal lock option is disabled upon shipment.

Force Bump When Overdue

When enabled, the **Force Bump When Overdue** option forces a bump check if the sensor has exceeded its bump check interval (see [Bump Interval](#)). If a successful bump check has not been performed, the detector will deactivate.

Language Menu

The detector is shipped with English as the default language displayed. You can choose to view the detector in these additional languages.

- French (**Français**);
- German (**Deutsch**);
- Spanish (**Español**); and
- Portuguese (**Português**).

Alarms

The following table describes the detector alarms and shows how the LCD looks for each alarm.

During an alarm condition, the detector activates the backlight, audible/visual/vibrator alarms, and the LCD shows the current ambient gas reading.

If more than one type or level of alarm exists at the same time, a multi-gas alarm will result.

To change the factory-set alarm setpoints, refer to the *GasAlertMicroClip Soft Tools* instruction sheet.

Table 6. Alarms

Alarms	Display	Alarms	Display
<p>Low Alarm:</p> <ul style="list-style-type: none"> • Slow siren • Slow alternating flash • ALARM and target gas bar flash • Vibrator alarm activates 		<p>High Alarm:</p> <ul style="list-style-type: none"> • Fast siren • Fast alternating flash • ALARM and target gas bar flash • Vibrator alarm activates 	
<p>TWA Alarm:</p> <ul style="list-style-type: none"> • Slow siren • Slow alternating flash • ALARM and target gas bar flash • Vibrator alarm activates 		<p>STEL Alarm:</p> <ul style="list-style-type: none"> • Fast siren • Fast alternating flash • ALARM and target gas bar flash • Vibrator alarm activates 	

Table 6. Alarms

Alarms	Display	Alarms	Display
<p>Multi-Gas Alarm:</p> <ul style="list-style-type: none"> • Alternating low and high alarm siren and flash • ALARM and target gas bars flash • Vibrator alarm activates 		<p>Over Range (OL) Alarm:</p> <ul style="list-style-type: none"> • Fast siren and alternating flash • ALARM and target gas bar flash • Vibrator alarm activates 	
<p>Sensor Alarm:</p> <ul style="list-style-type: none"> • Displays Err 		<p>Confidence Beep:</p> <ul style="list-style-type: none"> • One beep every 10 seconds 	
<p>Low Battery Alarm: (Confidence beep disabled)</p> <ul style="list-style-type: none"> • One beep and one flash every 5 seconds • and ALARM flashes 		<p>Automatic Shutdown Alarm:</p> <ul style="list-style-type: none"> • Eight beeps and eight flashes • LOW BAT and ALARM display • Vibrator alarm temporarily activates • Displays OFF before turning off 	

Table 6. Alarms

Alarms	Display
<p>Normal Shutdown:</p> <ul style="list-style-type: none"> • Four beeps and flashes • Vibrator alarm temporarily activates 	

Note

Alarms can be set to be latching or non-latching. To confirm this setting, access the [Latching Alarms](#) option in the GasAlertMicroClip Soft Tools. Local regulations may require a latching alarm.

If the detector is in stealth mode, it only vibrates in alarm mode (the audible and visual alarms are disabled). If the detector is in IR stealth mode, the IR LEDs and vibrator activate in alarm mode (the audible alarm is disabled).

If the low alarm acknowledge option is enabled, the audible alarm can be disabled only during a low alarm by pressing . The vibrator and LEDs remain activated. If the alarm escalates to a high, TWA, or STEL alarm, the audible alarm reactivates.

The backlight activates during any alarm condition.

Computed Gas Exposures

⚠ Warning

To avoid possible personal injury, do not deactivate the detector during a work shift. TWA, STEL, and MAX readings reset once the detector is deactivated.

Table 7. Computed Gas Exposures

Gas Exposure	Description
TWA (H ₂ S and CO only)	Time-weighted average (TWA) based on accumulated exposure to toxic gases averaged over a workday according to OSHA method. OSHA: 8 hour moving average
STEL (H ₂ S and CO only)	Short-term exposure limit (STEL) to gas based on a 5-15 minute user selectable period.
Maximum* (peak)	Maximum (MAX) concentration encountered during work shift.

* For oxygen, it is the highest or the lowest concentration encountered.

Viewing Gas Exposures

To view the TWA, STEL, and maximum (MAX) hold readings, press  twice. The LCD first displays the TWA gas exposures.

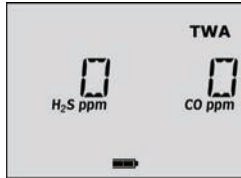

Then the LCD displays the STEL gas exposures.

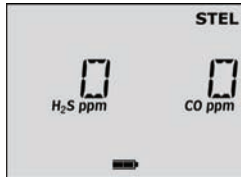

Finally the LCD displays the MAX readings.

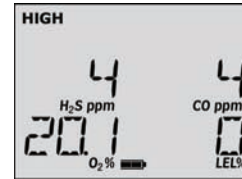

Clearing Gas Exposures

Caution

Follow all safety procedures as defined by your employer.

Confirm with your supervisor before clearing TWA and STEL alarms.

To clear the TWA, STEL, and MAX exposure readings, press  when the LCD displays **RESET**.



Gas Alarm Setpoints

The detector's gas alarm setpoints trigger the gas alarms that are described in the table below.

Table 8. Gas Alarm Setpoints

Alarm	Condition
Low alarm	<i>Toxics and combustibles:</i> Ambient gas level above low alarm setpoint. <i>Oxygen:</i> Ambient gas level may be set to above or below 20.9% (or 20.8%).
High alarm	<i>Toxics and combustibles:</i> Ambient gas level above high alarm setpoint. <i>Oxygen:</i> Ambient gas level may be set to above or below 20.9% (or 20.8%).
TWA alarm	<i>Toxic only:</i> Accumulated value above the TWA alarm setpoint.
STEL alarm	<i>Toxic only:</i> Accumulated value above the STEL alarm setpoint.
Multi-gas alarm	Two or more gas alarm conditions.

Resetting Gas Alarm Setpoints

Note

To change the alarm setpoints, you must connect the detector to the IR Link adapter and use the GasAlertMicroClip Soft Tools software. Refer to the GasAlertMicroClip Soft Tools manual for complete instructions.

Standard factory alarm setpoints will vary by region.

Occupational Safety and Health Association (OSHA) standard settings are used as an example.

The following table lists the factory alarm setpoints.

Table 9. Sample Factory Alarm Setpoints

Gas	TWA	STEL	Low	High
O ₂	N/A	N/A	19.5% vol.	23.5% vol.
LEL	N/A	N/A	10% LEL	20% LEL
CO	35 ppm	50 ppm	35 ppm	200 ppm
H ₂ S	10 ppm	15 ppm	10 ppm	15 ppm

Note

You can disable an alarm by setting the alarm setpoint to 0.

Stopping a Gas Alarm

The low and high alarms stop when the ambient gas level returns to the acceptable range.

Note

If alarms are set to latch, press  to reset the alarms.

The detector computes the TWA value based on OSHA standards and the STEL value based on a user selectable 5 to 15 minute period (see [STEL Interval](#)).

To stop a TWA or STEL alarm, perform one of the following:

1. Deactivate (see [Deactivating the Detector](#)) and reactivate (see [Activating the Detector](#)) the detector.
2. Reset the TWA/STEL/MAX exposure readings (see [Viewing Gas Exposures](#)).

Sensor Alarm

The detector tests for a missing or defective sensor on activation and continuously thereafter. If a sensor fails the self-test, **Err** appears above the gas bar of the failed sensor (refer to the [Troubleshooting](#) section).

Low Battery Alarm

The detector tests the battery on activation and continuously thereafter. Battery power is continually displayed during normal operation. If the battery voltage is low, the detector activates the low battery alarm.

The low battery alarm continues until you recharge the battery. If the battery voltage drops too low, the detector executes an automatic shutdown.

Note

If the confidence beep is on, the audible alarm does not beep during a low battery alarm (see [Confidence Beep](#)). Typically, the low battery alarm continues for 30 minutes before an automatic shutdown.

Automatic Shutdown Alarm

If the battery voltage is in immediate danger of dropping below the minimum operating voltage, **LOW BAT** and **ALARM** display, the audible alarm beeps eight times, and the visual alarm flashes eight times. The LCD then displays **OFF** before it deactivates and the detector stops normal operation. Charge the battery. See the section, [Charging the Detector](#).

Calibration

Guidelines

When calibrating the detector, adhere to the following guidelines:

- Recommended gas mixture:
CO: 50 to 500 ppm balance N₂
H₂S: 10 to 100 ppm balance N₂
LEL: 10 to 100% LEL or 0.5 to 5% by vol. methane
balance air
O₂: clean air, 20.9 % (or 20.8%)
- CG-Q58-4 and CG-Q34-4 calibration gas (4-gas mix) are available from BW Technologies by Honeywell. See the section, [Replacement Parts and Accessories](#).
- Calibration accuracy is never better than the calibration gas accuracy. BW Technologies by Honeywell recommends a premium-grade calibration gas. Gases with the National Institute of Standards and Technology (NIST) traceable accuracy improve the validity of the calibration. Do not use a gas cylinder beyond its expiration date.
- Calibrate a new sensor before use. Install the sensor, activate the detector, and allow the sensor to stabilize before starting calibration (used: 60 seconds; new: 5 minutes).
- Calibrate the detector at least once every 180 days, depending on use and sensor exposure to poisons and contaminants.
- Calibrate the detector if the ambient gas display varies at start-up.
- It is best to calibrate the sensor before changing the alarm setpoints.
- Calibrate only in a safe area that is free of hazardous gas.
- Do not calibrate the detector during or immediately after charging is complete.
- The oxygen sensor can be automatically calibrated each time upon activation (if this feature is enabled). Activate the detector in a normal (20.9%/20.8% oxygen) atmosphere.
- The detector should be allowed to stabilize for 1 minute after activation, prior to calibration or bump test.
- If you require a certified calibration, contact [BW Technologies by Honeywell](#).

Diagnostics Protection

The detector tests the ambient air (auto zero) and the test gas that is applied (auto span) to ensure it meets expected values.

If an unexpected level of target gas is present during an auto zero, the auto zero will fail for that sensor. The detector advises which sensor(s) failed the auto zero before proceeding to the auto span.

In auto span, if any target gas is not present or does not meet expected values, the display will advise you of that failure. The sensor(s) that failed to span will retain its previous set value and not continue with the calibration process.

Applying Gas to the Sensors

The calibration cap and hose, which is shipped with the detector, simplifies sensor testing and calibration. Figure 3 and Table 10 show how to use it when applying gas to the sensors.

Note

The calibration cap should only be used during the calibration span process.

Wind currents may cause false readings and poor calibrations.

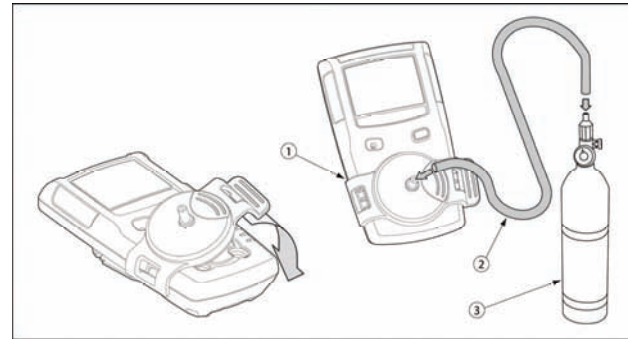

Figure 3. Applying Gas to the Sensors

Table 10. Applying Gas to the Sensors

Item	Description
1	Detector and calibration cap
2	Calibration hose
3	Regulator and gas cylinder

Calibration Procedure

To calibrate the detector perform the following procedure.

Note

Calibrate O₂ in clean air.

If is pressed at any time during the calibration procedure, calibration is **ABORTED**. The detector emits a quick beep and the calibration due dates are displayed before the detector returns to normal operation.



Start Calibration

Note

Verify that the calibration gas you are using matches the span concentration value(s) in the detector. See the section, [Calibration Gas Concentration](#).

1. In a clean atmosphere, press and hold as the detector beeps, flashes, and vibrates to the corresponding **OFF** countdown. Continue to hold as the detector briefly deactivates.



2. The detector then reactivates and performs the **CAL** countdown. Continue to hold until the **CAL** countdown is complete to enter calibration.



Note



If is not held for the entire **CAL** countdown, the detector will deactivate.

Auto Zero and Oxygen Sensor Calibration

Note

Do not apply calibration gas at this point, otherwise auto zero may fail for that sensor and then it cannot be spanned.

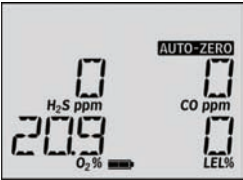
- The LCD flashes **AUTO-ZERO** while the detector automatically zeroes the toxic and combustible sensors and calibrates the oxygen sensor. The LCD notifies you if the auto zero has failed for a sensor.

Auto Zero	Sensor Fail
	

The audible alarm then beeps twice.

Auto Span

- The LCD now prompts you to apply calibration gas to the sensors.



- 🔊 flashes and **AUTO-SPAN** remains displayed as you attach the calibration cap and apply gas to the sensors at a flow rate of 250 to 500 ml/min. (refer to Figure 3. Applying Gas to the Sensors).

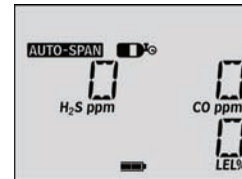

When the detector senses a sufficient amount of gas concentration (approximately 30 seconds), the audible alarm beeps once, **AUTO-SPAN** flashes, and  remains lit while the detector completes the span (approximately 2 minutes).



Successful Span

If the sensors have spanned successfully, the audible alarm beeps before the calibration procedure continues.

Unsuccessful Span

If the sensors fail the span, the LCD displays **FAILURE** before proceeding with the calibration procedure.

No Gas Detected

The LCD displays **FAILURE** if the detector does not detect any gas within 2 minutes before proceeding with the calibration procedure.



Note

The detector will not span a sensor if:

- *You do not apply gas to the sensor.*
- *The sensor fails to detect at least one-half of the expected gas concentration in the first 30 seconds.*
- *The gas concentration drops below one-half of the expected gas level during the 2 minute span.*

If you apply gas to a sensor and the detector fails to span the sensor, repeat the calibration procedure using a new gas cylinder. If the sensor fails the span a second time, replace the sensor. See the section, [Replacing a Sensor or Sensor Filter](#).

Calibration Due Date

Note

If a sensor does not successfully span, its calibration due date will not be reset.

- After span is complete, the LCD displays the following calibration due date screens before returning to normal operation.

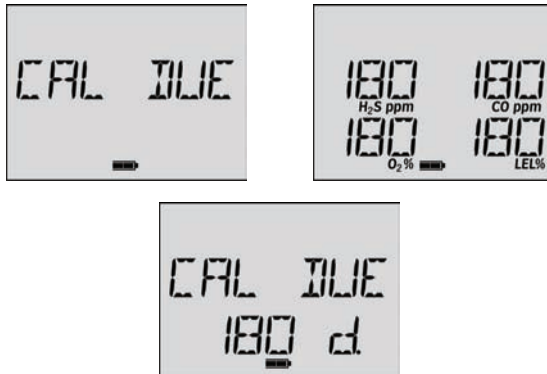

Note

The number of days shown in the last screen represents the earliest date a calibration needs to be performed.

If a sensor failed to successfully span and it is past its calibration due date, the LCD displays the following three screens.

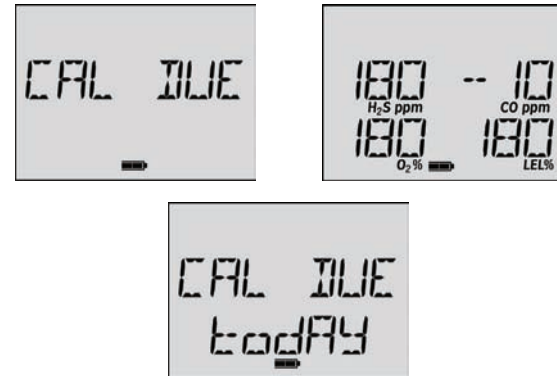

Press to acknowledge the warning before returning to normal operation.

Verification

After calibration is complete and the detector is in normal operating mode, test it using a gas cylinder other than the one used in calibration. The gas concentration should not exceed the sensor's detection range. Confirm that the LCD shows the expected concentration. To ensure the readings are accurate, apply the test gas for the same amount of time as was applied to the sensor when it was calibrated.

Datalogs

The datalogger allows the detector to record various information so you can compile a report. The detector has a sample rate of 15-second intervals. The detector is capable of storing 16 hours of information. When the memory is full, the detector replaces the oldest data with the most recent data.

Event Logs

The event logging feature keeps a record of the ten most recent gas alarm events. The information that is recorded from an event is as follows:

- Serial number;
- Gas type;
- Start time of event;

- Peak exposure level (ppm or %);
- Alarm duration in seconds; and
- Alarm type.

Downloading Datalogs and Event Logs

The datalog and event log files can only be downloaded to a PC using an IR device (e.g., IR Link Adapter or MicroDock II Base Station).

Maintenance

To keep the detector in good operating condition, perform the following basic maintenance as required:

- Calibrate, bump check, and inspect the detector at regular intervals.
- Keep an operations log of all maintenance, bump checks, calibrations, and alarm events.
- Clean the exterior with a soft damp cloth. Do not use solvents, soaps, or polishes.

Charging the Detector

⚠ Warning

- ⇒ **The detector must be charged in a non-hazardous atmosphere of 32°F - 113°F (0°C - 45°C).**
- ⇒ **Charge the detector using only the recommended charging adapter. Do not use any other charging adapter. Failure to observe this precaution can lead to fire or explosion.**
- ⇒ **The charging adapter is voltage specific to North America. Use of the charging adapter outside of North America will damage the charger and detector.**
- ⇒ **The battery can only be replaced by the manufacturer. Not complying with this might cause explosion danger.**

Note

To preserve battery life, deactivate the detector when you are not using it.

To charge the detector, execute the following steps:

1. Deactivate the detector and attach the GasAlertMicroClip charging adapter as shown in

the following figure. The detector can be activated during charging.

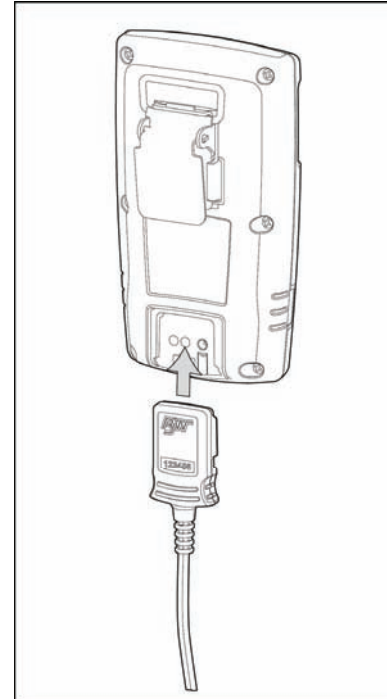



Figure 4. Connecting the Charging Adapter

2. Allow the detector to charge for 2-3 hours. The charging indicator flashes on the LCD while the detector is being charged.
3. Once charging is complete, the LCD continues to display . Remove the adapter and activate the detector.

Note

If the battery indicator does not display within 5 minutes, refer to the [Troubleshooting](#) section.

To reach full battery capacity, allow the battery to fully charge and fully discharge three times.

Charging the detector in temperatures above 113°F will greatly reduce the number of charges the detector can accept.

The detector may be hot immediately following charging. This is normal.

Replacing a Sensor or Sensor Filter

Warning

To avoid personal injury, use only sensors specifically designed for the detector. See the section [Replacement Parts and Accessories](#).

Each sensor has a high degree of resistance to common vapors and gases. A sensor will most likely clear itself if you move the detector to a clean environment and wait 10 to 30 minutes, but it could take up to a couple of days depending upon the gas that came in contact with the sensor. Do not expose a sensor to the vapors of inorganic solvents such as paint fumes or organic solvents. The [Troubleshooting](#) section describes problems caused by a sensor in need of calibration or replacement.

To replace a sensor or sensor filter, refer to the following figure, table, and set of instructions.

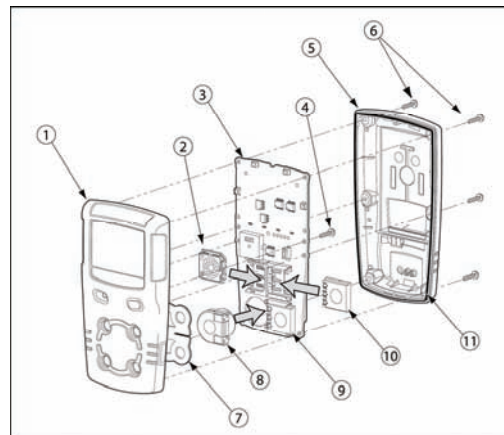

Figure 5. Replacing a Sensor or Sensor Filter

Table 11. Replacing a Sensor or Sensor Filter

Item	Description
1	Front shell
2	LEL sensor
3	PCB
4	PCB screws (2)
5	Rear shell
6	Machine screws (6)
7	Sensor filter
8	O ₂ sensor
9	H ₂ S sensor
10	CO sensor
11	Sealing rib

1. Deactivate the detector.
2. Remove the six machine screws on the rear shell and remove the back cover.

3. Remove the two screws on the PCB and remove the PCB.

Note

Ensure the battery does not get damaged once the PCB is removed.

4. Remove the old sensor filter or slide/pull out the old sensor(s).
5. Insert a new sensor filter or sensor(s).

Note

When inserting a new sensor filter, ensure the white side is facing the sensors (i.e., the black side is facing out).

Detectors that are configured for 1, 2, or 3 gases may contain a dummy sensor in one of the four sensor locations.

6. Re-assemble the detector. When assembling the detector, be aware of the following:
 - Ensure the charging contact pins inside the rear shell are lined up to its appropriate hole before inserting the rear shell in place. If the contact pins are bent, the battery cannot charge properly.
 - Verify that the battery PCB is in the same position as when the rear shell was removed (refer back to step #2).
 - Visually inspect the battery to ensure that it has not been damaged before replacing the rear shell.
 - Ensure the rib on the interior of the rear shell fits between the battery pack and the PCB as shown in Figure 6.
 - Ensure the rear shell sealing rib is not folded when replacing the rear shell (see Figure 5).
 - Torque the screws to 3-4 in-lbs in a crisscross pattern to ensure a proper environment seal.

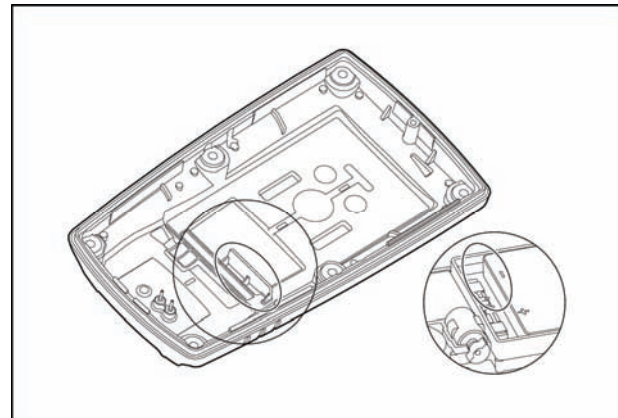

Figure 6. Replacing the Rear Shell

Calibrate the detector after changing any sensor. See the section, [Calibration](#).

Troubleshooting

The detector's electronics are protected from variations in humidity and corrosive atmospheres. If you encounter a problem, try the solutions listed in the following table.

If you are still unable to correct the problem, contact [BW Technologies by Honeywell](#).

Table 12. Troubleshooting Tips

Problem	Possible Cause	Solution
The detector does not activate.	<ul style="list-style-type: none"> → Depleted battery → Damaged or defective detector 	<ul style="list-style-type: none"> → Charge battery (see Charging the Detector) → Contact BW Technologies by Honeywell
The detector enters alarm mode immediately when activated.	<ul style="list-style-type: none"> → Sensor needs to stabilize → Low battery alarm → Detector requires calibration 	<ul style="list-style-type: none"> → Used sensor: wait 60 seconds New sensor: wait 5 minutes → Charge battery (see Charging the Detector) → Calibrate detector (see Calibration)
The activation self-test fails.	<ul style="list-style-type: none"> → General fault → Sensor failure 	<ul style="list-style-type: none"> → Contact BW Technologies by Honeywell → Replace sensor (see Replacing a Sensor or Sensor Filter)

Table 12. Troubleshooting Tips (cont.)

Problem	Possible Cause	Solution
<p>Detector does not display normal ambient gas reading after activation self-test.</p>	<ul style="list-style-type: none"> → Sensor not stabilized → Detector requires calibration → Target gas is present 	<ul style="list-style-type: none"> → Used sensor: wait 60 seconds New sensor: wait 5 minutes → Calibrate detector (see Calibration) → Detector is operating properly. Use caution in suspect areas
<p>Detector does not respond to pushbutton.</p>	<ul style="list-style-type: none"> → Battery is depleted → Detector is performing operations that do not require user input 	<ul style="list-style-type: none"> → Charge battery (see Charging the Detector) → Pushbutton operation restored automatically when the operation ends
<p>Detector does not accurately measure gas.</p>	<ul style="list-style-type: none"> → Detector requires calibration → Detector is colder/hotter than ambient gas → Sensor filter is blocked 	<ul style="list-style-type: none"> → Calibrate sensor (see Calibration) → Allow the detector to acquire ambient temperature before use → Clean the sensor filter (see Replacing a Sensor or Sensor Filter)
<p>Detector has been charging for over 3 hours and the charging indicator still indicates that the battery has not finished charging.</p>	<ul style="list-style-type: none"> → Battery is trickle charging 	<ul style="list-style-type: none"> → Battery is full and ready for operation

Table 12. Troubleshooting Tips (cont.)

Problem	Possible Cause	Solution
Detector does not enter alarm.	<ul style="list-style-type: none"> → Alarm setpoint(s) are set incorrectly → Alarm setpoint(s) set to zero → Detector is in calibration mode 	<ul style="list-style-type: none"> → Reset alarm setpoints (see Resetting Gas Alarm Setpoints) → Reset alarm setpoints (see Resetting Gas Alarm Setpoints) → Complete the calibration procedure
Detector intermittently enters alarm without apparent reason.	<ul style="list-style-type: none"> → Ambient gas levels are near alarm setpoint or the sensor is exposed to a puff of the target gas → Alarms set incorrectly → Detector requires calibration → Missing or faulty sensor 	<ul style="list-style-type: none"> → Detector is operating normally. Use caution in suspect areas. Check maximum gas exposure reading. → Reset alarm setpoints (see Resetting Gas Alarm Setpoints) → Calibrate sensors (see Calibration) → Replace sensor (see Replacing a Sensor or Sensor Filter)
Detector automatically deactivates.	<ul style="list-style-type: none"> → Automatic shutdown feature activated due to weak battery 	<ul style="list-style-type: none"> → Charge detector (see Charging the Detector)
Battery indicator does not display when charging.	<ul style="list-style-type: none"> → Detector may be depleted below normal levels 	<ul style="list-style-type: none"> → Charge detector for approximately 8 hours. Detector LEDs may light during first 5 hours. This is normal. → If the battery indicator does not light after charging for 8 hours, contact BW Technologies by Honeywell.

Replacement Parts and Accessories

⚠ Warning

To avoid personal injury or damage to the detector, use only the specified replacement parts.

To order parts or accessories listed in the following table, contact [BW Technologies by Honeywell](#).

Table 13. Replacement Parts and Accessories

Model No.	Description	Qty
SR-W-MC	Replacement combustible sensor	1
SR-X-MC	Replacement O ₂ sensor	1
SR-M-MC	Replacement CO sensor	1
SR-H-MC	Replacement H ₂ S sensor	1
REG-0.5	Regulator (0.5 l/min)	1
CG-Q58-4	Quad gas cylinder: CH ₄ -2.5%, O ₂ -18.0%, H ₂ S-25 ppm, CO-100 ppm, bal. N ₂ (58 l)	1
CG-Q34-4	Quad gas cylinder: CH ₄ -2.5%, O ₂ -18.0%, H ₂ S-25 ppm, CO-100 ppm, bal. N ₂ (34 l)	1
CG-T34	Dual gas cylinder: 50% LEL (CH ₄ -2.5%) O ₂ -20.9%, bal. N ₂ (34 l)	1

Model No.	Description	Qty
G0042-H25	Single gas cylinder: H ₂ S 25 ppm, bal. N ₂ (58 l)	1
CG2-M-200-103	Single gas cylinder: CO 200 ppm, bal N ₂ (103 l)	1
CG-BUMP1	Bump alarm gas aerosol (CH ₄ -2.5%, O ₂ -10%, H ₂ S-40 ppm, CO-200 ppm)	1
CK-Q34-4	Quad calibration kit with regulator, quad gas cylinder (CG-Q34-4), hose, and carrying case	1
CK-Q58-4	Quad calibration kit with regulator, quad gas cylinder (CG-Q58-4), hose, and carrying case	1
MC-XWHM-Y-NA-07	Confined space kit with manual aspirator pump	1
DOCK2-0-1C1L-00-N	GasAlertMicroClip MicroDock II docking module with charging cable	1
MC-SCREW-K1	Screw kit (5 sets of screws and screwdriver)	1
MC-AF-K1	Auxiliary filter kit	1
MC-SS-AF-K1	Replacement auxiliary filters	10
MC-SS	Sensor filters	2
MC-PA-1	Replacement charging adapter	1

Model No.	Description	Qty
MC-VC-K1	Vehicle charging kit	1
MC-C01-MC5*	GasAlertMicroClip MultiCharger	1
GA-USB1-IR	IR connectivity kit	1
GA-PA-1*	Charging adapter	1
MC-TC-1	Calibration cap and hose (1 ft./3 m)	1
GA-AG-3	Alligator clip (stainless steel)	1

**Add suffix (-UK) for United Kingdom mains plug, (-EU) for European mains plug, (-AU) for Australian mains plug.*

Specifications

Instrument dimensions: 10.75 x 6.00 x 2.73 cm
(4.2 x 2.4 x 1.1 in.)

Weight: 160 g (5.7 oz.)

Operating temperature: -20°C to +58°C (-4°F to +136°F)
+50°C to +58°C is certified by CSA-International on the combustible sensor with ±5% accuracy

Storage temperature: -40°C to +50°C (-40°F to +122°F)

Operating humidity: 0% to 95% relative humidity
(non-condensing)

Alarm setpoints: May vary by region and are user-settable

Detection range:

H₂S: 0 – 100 ppm (1 / 0.1 ppm increments)

H₂S: 0 – 200 ppm (1 ppm increments)

CO: 0 – 500 ppm (1 ppm increments)

CO: 0 – 1000 ppm (1 ppm increments)

O₂: 0 – 30.0% vol. (0.1% vol. increments)

Combustible (LEL): 0 – 100% LEL (1% LEL increments) or
0 – 5.0% v/v methane

Sensor type:

H₂S, CO, O₂: Single plug-in electrochemical cell

Combustibles: Plug-in catalytic bead

O₂ measuring principle: Capillary controlled concentration sensor

Alarm conditions: TWA alarm, STEL alarm, low alarm, high alarm, multi-gas alarm, over range (OL) alarm, low battery alarm, confidence beep, automatic shutdown alarm

Audible alarm: 95 dB+ at 30 cm (100 dB typical) variable pulsed beeper

Visual alarm: Red light-emitting diodes (LED)

Display: Alphanumeric liquid crystal display (LCD)

Backlight: Activates when the pushbutton is pressed and deactivates after 5 seconds. Also activates during an alarm condition.

Self-test: Initiated upon activation

Calibration: Automatic zero and automatic span

Oxygen sensor: Automatic span upon activation
(selectable)

User field options: Start-up message, confidence beep, latching alarm, enable/disable safe display mode, oxygen measurement, combustible sensor measurement, sensor disable, set calibration interval, force calibration, calibration due lock, force bump, bump interval, stealth mode, IR stealth mode, low alarm acknowledge, language selection, enable/disable automatic oxygen calibration, enable/disable auto zero at start-up, set alarm setpoints, set span concentration values, set STEL calculation period.

Battery operating time:

1 rechargeable lithium polymer: 10-12 hours (typical)

Year of manufacture: The detector's year of manufacture is determined from the serial number. The second and third number after the first letter determines the year of manufacture.

E.g., H304-Y000001 = 2004 year of manufacture

Approved battery:

North America

Approved batteries for product (standards EN50020, UL913, C22.2 No. 157)

Rechargeable battery

Lithium polymer

Temperature code

T4

Battery charger: GasAlertMicroClip charging adapter

First-time charge: 2-3 hours

Normal charge: 2-3 hours

Warranty: 2 years including sensors

Approvals:

Approved by CSA to both U.S. and Canadian Standards CAN/CSA C22.2 No. 157 and C22.2 152

ANS/UL – 913 and ANSI/ISA – S12.13 Part 1

CSA Class I, Division 1, Group A, B, C, and D

ATEX CE 0539 Ⓢ II 1 G EEx ia IIC T4

KEMA 06ATEX0056

IECEX Ex ia IIC T4

This equipment has been tested and found to comply with the limits for a Class B digital device, pursuant to Part 15 of the FCC Rules and ICES-003 Canadian EMI requirements. These limits are designed to provide reasonable protection against harmful interference in a residential installation. This equipment generates, uses and can radiate radio frequency energy and, if not installed and used in accordance with the instructions, may cause harmful interference to radio communications. However, there is no guarantee that interference will not occur in a particular installation. If this equipment does cause harmful interference to radio or television reception, which can be determined by turning the equipment off and on, the user is encouraged to try to correct the interference by one of more of the following measures:

- Reorient or relocate the receiving antenna.
- Increase the separation between the equipment and receiver.
- Connect the equipment into an outlet on a circuit different from that to which the receiver is connected.
- Consult the dealer or an experienced radio/TV technician for help.

General Datalogger Specifications

Storage: 16 hours at 15-second intervals

Memory type: Wraparound memory ensures most recent data is always saved

Sample rate: One reading every 15 seconds

Data recorded: All sensor readings, all alarm conditions, calibrations, event flags, battery status, sensor status, confidence beep activation, and detector status along with the time and date for each reading and unit serial number

Operation: Requires no user intervention (automatic)

Compatible with: Desktop PC computer or laptop

Operating system: Windows 2000 or higher

Download via: IR device (e.g., IR Link adapter, MicroDock II Base Station, etc.)

Software required: Soft Tools with spreadsheet/database compatible with comma-separated-value (CSV) text files (Excel, Access, Quattro, etc.)

D5908/2 English

iERP: 124291

© BW Technologies 2007, all rights reserved. Printed in Canada.

All product names are trademarks of their respective companies.





Corporate Headquarters
Calgary, Alberta
by Honeywell

ERRATA CARD

125109
GasAlertMicroClip

The following information has changed in the user manual (124291 D5908/2)

Pages 9 & 10

⚠ Caution

Only activate the detector in a safe area that is free of hazardous gas.

Page 19

Auto Zero on Start-up

The auto zero option for each sensor is enabled upon shipment.

3¾ in.

5½ in.

Printing Information

iERP #	125109
Size:	3¾ x 5½ inches
Stock:	80 lb cougar cover card stock
Print Color:	Black
Language:	English



DAILY BUMP TEST

iERP: 125538



IMPORTANT NOTE

BW recommends to “bump test” the sensor(s), before each day’s use to confirm their ability to respond to gas by exposing the detector to a gas concentration that exceeds the alarm setpoints. Manually verify that the audible and visual alarms are activated.

If any sensor fails the bump test, contact your local BW service department immediately.