



GasAlertMicro

H₂S, CO, O₂, SO₂, Combustibles

1, 2, 3, and 4 Gas Detectors

User Manual



Limited Warranty & Limitation of Liability

BW Technologies LP (BW) warrants this product to be free from defects in material and workmanship under normal use and service for a period of two years, beginning on the date of shipment to the buyer. This warranty extends only to the sale of new and unused products to the original buyer. BW's warranty obligation is limited, at BW's option, to refund of the purchase price, repair, or replacement of a defective product that is returned to a BW authorized service center within the warranty period. In no event shall BW's liability hereunder exceed the purchase price actually paid by the buyer for the Product.

This warranty does not include:

- a) fuses, disposable batteries or the routine replacement of parts due to the normal wear and tear of the product arising from use;
- b) any product which in BW's opinion, has been misused, altered, neglected or damaged by accident or abnormal conditions of operation, handling or use;
- c) any damage or defects attributable to repair of the product by any person other than an authorized dealer, or the installation of unapproved parts on the product; or

The obligations set forth in this warranty are conditional on:

- a) proper storage, installation, calibration, use, maintenance and compliance with the product manual instructions and any other applicable recommendations of BW;
- b) the buyer promptly notifying BW of any defect and, if required, promptly making the product available for correction. No goods shall be returned to BW until receipt by the buyer of shipping instructions from BW; and
- c) the right of BW to require that the buyer provide proof of purchase such as the original invoice, bill of sale or packing slip to establish that the product is within the warranty period.

THE BUYER AGREES THAT THIS WARRANTY IS THE BUYER'S SOLE AND EXCLUSIVE REMEDY AND IS IN LIEU OF ALL OTHER WARRANTIES, EXPRESS OR IMPLIED, INCLUDING BUT NOT LIMITED TO ANY IMPLIED WARRANTY OF MERCHANTABILITY OR FITNESS FOR A PARTICULAR PURPOSE. BW SHALL NOT BE LIABLE FOR ANY SPECIAL, INDIRECT, INCIDENTAL OR CONSEQUENTIAL DAMAGES OR LOSSES, INCLUDING LOSS OF DATA, WHETHER ARISING FROM BREACH OF WARRANTY OR BASED ON CONTRACT, TORT OR RELIANCE OR ANY OTHER THEORY.

Since some countries or states do not allow limitation of the term of an implied warranty, or exclusion or limitation of incidental or consequential damages, the limitations and exclusions of this warranty may not apply to every buyer. If any provision of this warranty is held invalid or unenforceable by a court of competent jurisdiction, such holding will not affect the validity or enforceability of any other provision.

BW Technologies LP
2840 – 2nd Ave. SE
Calgary, AB
Canada T2A 7X9

BW America
3279 West Pioneer Parkway
Arlington, TX
USA 76013

BW Europe
101 Heyford Park,
Upper Heyford, Oxfordshire
United Kingdom OX25 5HA

Table of Contents

Title	Page
Introduction.....	1
Contacting BW Technologies.....	2
Safety Information - Read First.....	2
Getting Started.....	6
Parts of the GasAlertMicro Detector.....	7
Installing Alkaline Batteries.....	10
Activating the Detector.....	10
Self-Test.....	10
Self-Test Pass.....	14
Self-Test Fail.....	14
Battery Test.....	14
Datalogger Operation (optional).....	14
Deactivating the Detector.....	15
Confidence Beep.....	15
User Options Menu.....	16
Software Level.....	17
Finish Options.....	17
Latching Alarms.....	17
Safe Display.....	18
Combustible Sensor Measuring Selection.....	19
French.....	21
German.....	21
Spanish.....	22

Title	Page
Portuguese.....	22
English	23
Sensor Options	23
Pass Code Protection	25
Automatic Oxygen Calibration	27
Span Concentration	28
STEL Calculation Period.....	29
Stealth Mode.....	30
Automatic Backlight	31
MicroBatt Mode.....	31
Bump Due Reminder	32
Adjust Clock	33
Logger Rate	34
Alarms	35
Gas Exposures Computed.....	38
Viewing Gas Exposures.....	38
Gas Alarm Setpoints.....	39
Resetting Gas Alarm Setpoints.....	39
Stopping a Gas Alarm.....	39
Sensor Alarm	40
Low Battery Alarm.....	40
Automatic Shutdown Alarm	40
Calibration and Setting Alarm Setpoints	40
Calibration Guidelines.....	40
Diagnostics Protection	41
Attaching the Gas Cylinder to the Detector	42
Calibration Procedures	43

Title	Page
MultiMediaCard (MMC).....	50
MultiMediaCard Troubleshooting	51
Recovering Data Files	51
Direct Import to Compatible Programs	52
Determining Application Compatibility.....	53
Descriptions of Line Examples	56
Maintenance.....	56
Inserting the MultiMediaCard (MMC).....	57
Replacing the Batteries	57
Replacing a Sensor or Sensor Filter	59
Troubleshooting	62
Replacement Parts and Accessories.....	65
Specifications	69

List of Tables

Table	Title	Page
1.	Gases Monitored	1
2.	International Symbols	5
3.	GasAlertMicro Detector	7
4.	Display Elements	8
5.	Pushbuttons	9
6.	Alarms	35
7.	Computed Gas Exposures	38
8.	Gas Alarm Setpoints	39
9.	Sample Factory Set Alarm Setpoints	39
10.	Attaching the Gas Cylinder to the Detector	42
11.	Datalogger Status Codes	54
12.	CSV File Example	55
13.	Replacing the Batteries	58
14.	Torque Specs	60
15.	Replacing a Sensor or Sensor Filter	60
16.	Troubleshooting Tips	62
17.	Replacement Parts and Accessories	65

List of Figures

Figure Title	Page
1. GasAlertMicro Detector	7
2. Display Elements	8
3. Installing the Batteries	10
4. Attaching the Gas Cylinder to the Detector	42
5. Inserting the MultiMediaCard (MMC).....	57
6. Replacing the Batteries	58
7. Replacing a Sensor or Sensor Filter	61

CAUTION: FOR SAFETY REASONS, THIS EQUIPMENT MUST BE OPERATED AND SERVICED BY QUALIFIED PERSONNEL ONLY. READ AND UNDERSTAND THE USER MANUAL COMPLETELY BEFORE OPERATING OR SERVICING.

GasAlertMicro Multi-Gas Detector

Standard instrument is equipped with integral concussion-proof boot and internal vibrator alarm.

GasAlertMicro with User Downloadable Datalogger

Provides full time continuous datalogging while the instrument is operating. Data is saved on a convenient MultiMediaCard (MMC) and can be removed and downloaded by the user. Data is imported into standard office software (Microsoft® Excel, Access etc.). Wraparound memory ensures the most recent data is always saved.

Accessing Test Results with Fleet Manager

To access and view test results using the Fleet Manager software application, please refer to the Fleet Manager Support CD.

Accessing Test Results with EDM

To access and view test results using the Excel Datalog Manager (EDM) software application, please refer to the EDM CD.

GasAlertMicro

Introduction

⚠ Warning

To ensure your personal safety, read “Safety Information” before using the detector.

The GasAlertMicro gas detector (“the detector”) is designed to warn of hazardous gas at levels above user-selectable alarm setpoints.

The detector is a personal safety device. It is your responsibility to respond properly to the alarm.

Table 1 lists the gases that are monitored.

Table 1. Gases Monitored

Gas Detected	Unit of Measure
Hydrogen sulfide (H ₂ S)	parts per million (ppm)
Carbon monoxide (CO)	parts per million (ppm)
Oxygen (O ₂)	percent by volume (%)
Combustible gases field selectable for:	a) percent of lower explosive limit (% LEL) b) percent by volume methane 0-5.0% v/v
Sulfur dioxide (SO ₂)	parts per million (ppm)

Contacting BW Technologies

To contact BW Technologies call:

USA: 1-888-749-8878

Canada: 1-800-663-4164

Europe: +44 (0) 1869 233004

Other countries: +1-403-248-9226

Address correspondence to:

BW Technologies LP

2840 – 2 Avenue S.E.

Calgary, AB T2A 7X9

CANADA

Email us at: info@bwtnet.com

Visit our website at: www.gasmonitors.com

ISO 9001

Safety Information - Read First

Use the detector only as specified in this manual otherwise the protection provided by the detector may be impaired.

International symbols used on the detector and in this manual are explained in Table 2.

Read the **Warnings** and **Cautions** on the following pages before using the detector.



Note

This instrument contains batteries. Do not mix with the solid waste stream. Spent batteries should be disposed of by a qualified recycler or hazardous materials handler.





 **Cautions**

- ⇒ **Warning:** Substitution of components may impair Intrinsic Safety.
- ⇒ Do not use the detector if it is damaged. Inspect the case before use. Look for cracks and missing parts.
- ⇒ If the detector is damaged or parts are missing, contact [BW Technologies](#) immediately.
- ⇒ Ensure the battery compartment is locked in place before operating the detector.
- ⇒ Use only a sensor that is specifically designed for the GasAlertMicro model. Refer to [Replacement Parts and Accessories](#).
- ⇒ Calibrate the detector before first-time use and continue on a regular schedule. The schedule will depend upon use and sensor exposure to poisons and contaminants. BW recommends that calibration be performed a minimum of once every 180 days (6 months).
- ⇒ BW recommends to “bump test” the sensors, before each day’s use, to confirm their ability to respond to gas by exposing the detector to a gas concentration that exceeds the high alarm setpoints. Manually verify that the audible and visual alarms are activated. Calibrate if the readings are not within the specified limits.
- ⇒ BW recommends that the combustible sensor be checked with a known concentration of calibration gas after any known exposure to catalyst contaminants/poisons (sulfur compounds, silicon vapors, halogenated compounds, etc.).
- ⇒ The combustible sensor is factory calibrated to 50% LEL methane. If monitoring a different combustible gas in the % LEL range, calibrate the sensor using the selected gas. High off-scale % LEL or % v/v methane readings may indicate an explosive concentration.
- ⇒ Protect the combustible sensor from exposure to lead compounds, silicones, and chlorinated hydrocarbons. Selected organic vapors (ie. leaded gasoline and halogenated hydrocarbons) may temporarily inhibit sensor performance. However, in most cases the sensor will recover after calibration.

 **Cautions (cont.)**

- ⇒ Any rapid up-scaling reading that is followed by a declining or erratic reading can indicate a gas concentration beyond upper scale limit. It may be hazardous!
- ⇒ Use only recommended AA alkaline or NiMH batteries that are properly charged and installed in the detector case. Refer to [Replacement Parts and Accessories](#).
- ⇒ Charge NiMH batteries using the recommended charger only. Do not use any other charger. Failure to observe this precaution can lead to fire or explosion.
- ⇒ Do not change or charge batteries in a hazardous location. Doing so will impair the Intrinsic Safety of the unit and can lead to fire or explosion.
- ⇒ Read and observe all instructions and precautions that are provided with the charger. Failure to do so can result in fire, electric shock, or other forms of personal injury and property damage.
- ⇒ Extended exposure of the GasAlertMicro to high concentrations of combustible gases and air may stress a detector element, which can seriously affect its performance. If an alarm occurs due to high concentration of combustible gases, recalibrate immediately. If required, replace the sensor.
- ⇒ Do not test the combustible sensor response with a butane cigarette lighter. This will damage the sensor.
- ⇒ Do not expose the detector to electrical shock or severe mechanical shock.
- ⇒ Do not attempt to disassemble, adjust, or service the detector unless instructions in the User Manual are provided to perform a procedure, or if a part is listed as a replacement part. Use only [BW Technologies replacement parts](#).
- ⇒ Do not immerse the detector in liquids.
- ⇒ The detector Warranty will be voided if a customer, personnel, or third parties damage the detector during repair attempts. Any Non-BW Technologies repair/service attempts will void this Warranty.

Table 2. International Symbols

Symbol	Meaning
	Approved to both U.S. and Canadian Standards by the Canadian Standards Association
	European Explosives Protection
	Conforms to European Union Directives
BAM	BAM performance verification to European Performance Standards
ATEX	Conforms to European ATEX Directives
IECEx	International Electrotechnical Commission Scheme for Certification to Standards for Electrical Equipment for Explosive Atmospheres
	Type approved by ABS America for use aboard cargo vessels

Getting Started

Confirm that the standard items listed below are included with your detector. If the detector is damaged or parts are missing, contact the place of purchase immediately.

- Batteries (two replaceable alkaline cells, four NiMH rechargeable cells, or one GA MicroBatt cell)
- Charger (if applicable) one AC/DC line charger or one GA MicroBatt charger
- O₂ sensor
- Combustible sensor
- Four-gas units - one H₂S/CO sensor (dual sensor)
- Three-gas units - one applicable toxic sensor.
- Calibration hose and cap
- Quick reference guide
- CD

To order replacement parts, refer to [Replacement Parts and Accessories](#).

Each detector is manufactured with sensors installed. Refer to [Maintenance](#) before installing the batteries.

For information about the features and functions of the detector, refer to the following figures and tables:

- Figure 1 and Table 3: GasAlertMicro Detector
- Figure 2 and Table 4: Display Elements
- Table 5: Pushbuttons

Parts of the GasAlertMicro Detector

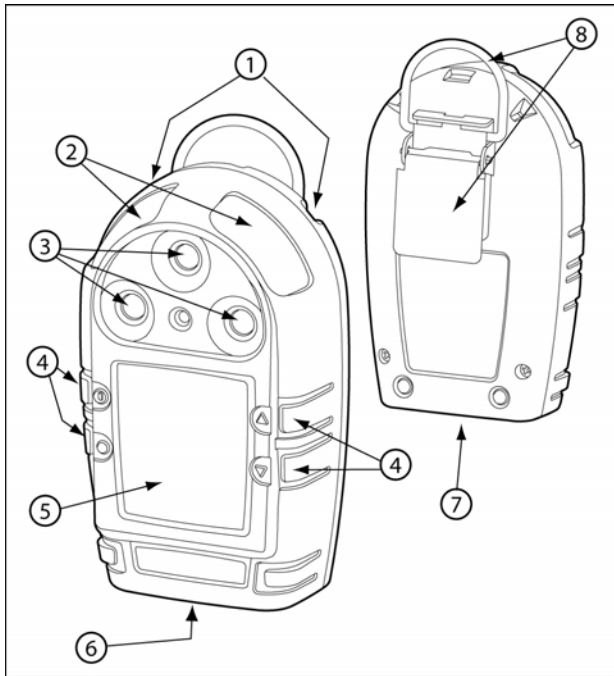

Figure 1. GasAlertMicro Detector

Table 3. GasAlertMicro Detector

Item	Description
1	Audible alarms
2	Visual alarm bars
3	Sensors
4	Pushbuttons
5	Display
6	Battery compartment
7	Datalogger (optional)
8	Alligator clip

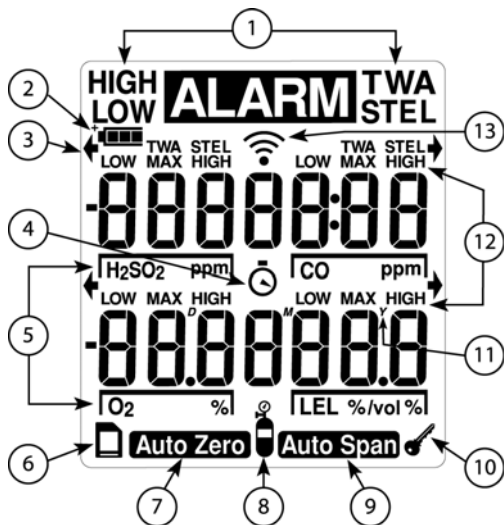

Figure 2. Display Elements

Note

When an alarm condition occurs and there is insufficient light to view the LCD, the backlight automatically activates for 10 seconds. Push any pushbutton to reactivate the backlight in low-light conditions. The detector is shipped with the auto backlight option enabled.

Table 4. Display Elements

Item	Function
1	Alarm condition
2	Battery life indicator
3	Button indicator (displays when a button press is allowed).
4	Clock
5	Gas identifier bars
6	Datalogger card indicator (optional)
7	Automatically zero sensor
8	Gas cylinder
9	Automatically span sensor
10	Pass code lock
11	Real time calendar (date, month, year)
12	Alarm condition (low, high TWA, STEL, or multi-gas), or view TWA, STEL, and maximum (MAX) gas exposures
13	Future use

Table 5. Pushbuttons

Pushbutton	Description
Ⓞ	<ul style="list-style-type: none"> • To activate the detector press Ⓞ. • To deactivate the detector, press Ⓞ and hold until OFF displays (approximately 5 seconds). • To enable/disable the confidence beep, when the detector is deactivated press and hold ○. While holding ○, press Ⓞ. This enables/disables the confidence beep while activating the start-up process. • To bypass calibration after auto zero press Ⓞ. • To access the software level information, press Ⓞ at any time from any of the user options.
▲	<ul style="list-style-type: none"> • To increment a displayed value or to scroll up press ▲. • To enter the user options menu, press ▲ and ▼ simultaneously and hold for 5 seconds. • To clear the TWA, STEL, and MAX gas exposure readings, press ○ and ▲ simultaneously. • To quickly scroll through options press and hold ▲.
▼	<ul style="list-style-type: none"> • To decrement a displayed value or scroll down press ▼. • To initiate calibration and enter alarm setpoints, press ○ and ▼ simultaneously and hold for 5 seconds. • To quickly scroll through options press and hold ▼.
○	<ul style="list-style-type: none"> • To view the TWA, STEL, and MAX hold readings, press ○. • To acknowledge latched alarms press ○. • To acknowledge a failed bump test screen press ○. • At any time after auto zero, and only prior to calibration gas being detected, press ○ to bypass calibration and proceed to alarm setpoints.

Installing Alkaline Batteries

If the detector uses alkaline batteries they need to be installed before activation. Refer to the following figure and instructions to install the batteries.

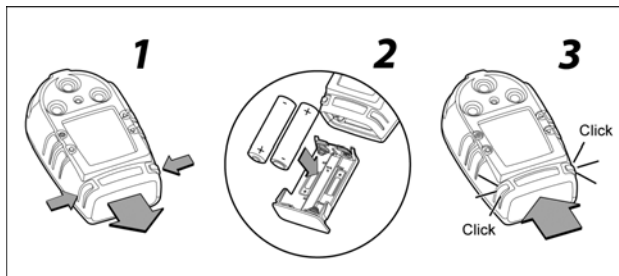



Figure 3. Installing the Batteries

1. Press the two release tabs on the detector.
2. Remove the battery tray by pulling the bottom away from the detector.
3. Install the alkaline batteries that are included with the detector. Polarity markings are shown inside the battery tray.
4. Insert the battery tray into the detector. Push until the release tabs click.

Activating the Detector

To activate the detector and only in an area that is free from hazardous gases (20.9% oxygen), press .

Self-Test

When the detector is activated it performs several system tests. Verify that all tests have been performed prior to using the detector.

The following tests are listed in the order they are performed and displayed on the detector.

1. **Low Battery Test:** If battery power is extremely low,  **LOW** flashes and the LCD displays **OFF**.



Replace the batteries and restart the detector before proceeding.

Note

At any time during activation, if the battery power is extremely low the detector will shut down. For more information, refer to [Confidence Beep](#).

2. **Detector Elements Test:** All of the display elements briefly turn on during start-up.



3. **Date Test** (optional): This test displays the day of the week (1-7), the time (hour/minutes), and the date (day/month/year).

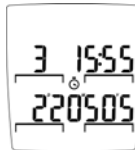

4. **Backlight Test:** The backlight turns on and then off.
5. **Alarm Setpoints Test:** The TWA, STEL, low, and high alarm setpoints display.

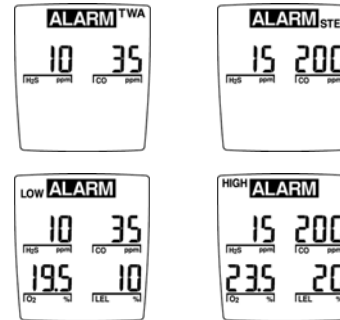

Note

Alarm setpoints can vary according to region. For more information, refer to [Resetting Gas Alarm Setpoints](#).

6. **Calibration Status Test:** Calibration status displays the number of days remaining before calibration is due.

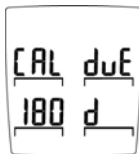

If calibration is overdue, an audible alarm sounds and the LCD displays the number of days the calibration is overdue.

To acknowledge the alarm, complete the following:

Press to acknowledge and silence the audible alarm.

Once in normal operation mode, calibrate the detector. Refer to [Calibration and Setting Alarm Points](#).

7. **Bump Check Reminder Test** (optional): The detector can be enabled to remind when a bump check is due. If this feature is enabled and bump check is due, the LCD displays the following screens:



The detector beeps twice, flashes once, and emits one vibration.

1. To temporarily bypass the reminder, hold the button for two seconds.

Note

Bypassing the reminder is temporary. The reminder will display and alarm the next time the detector is activated.

2. To bump the detector using the MicroDock II Automatic Test and Calibration Station, refer to the MicroDock II User Manual.

If the detector has recently failed a bump test in the MicroDock II, the detector's LCD displays **nOtE: bunP tEST hAS FAiLEd**.

3. Press to acknowledge the warning.
4. From the MicroDock II run another bump check.

8. **Sensor Test:** The LCD displays **tEst** when the detector tests the sensors.



If a sensor fails the self-test, the detector indicates an alarm by beeping, flashing, and vibrating. The LCD displays **SEnSor _ hAS FAiLed** and lists which sensor has failed.



Sensor 1: CO/H₂S or SO₂

Sensor 2: LEL

Sensor 3: Oxygen

9. **MultiMediaCard (MMC) Test:** (optional): If there is no MMC card installed, the LCD displays a scrolling error message.

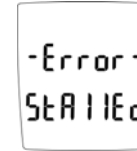
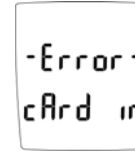
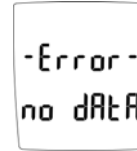

The card is not required for operation; the message is a reminder only.

10. **Oxygen Sensor Test:** Unless this feature is disabled, the oxygen sensor is calibrated automatically.



If the automatic oxygen calibration feature has been disabled, the LCD displays the O₂ calibration current mode screen.

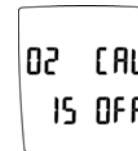

Self-Test Pass

After the self-test has been completed and any alarms have been acknowledged, the detector begins normal operation. The LCD then displays the current ambient gas readings.

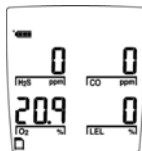

The detector begins recording immediately. It records the

- maximum (MAX) gas exposure,
- records the short-term exposure levels (STEL), and
- calculates the time-weighted average (TWA) exposures.

When the air is at acceptable levels, and if the safe option is enabled, **SAFE** scrolls across the screen continually while in normal operating mode. **SAFE** does not display while functions are being performed.



Note

This option is disabled in stealth mode.

Self-Test Fail

If the detector fails the self-test, refer to [Troubleshooting](#).

Battery Test

The detector tests the batteries upon activation and continuously thereafter. The battery power icon  displays at all times while in normal operation mode. If the battery voltage is low, the detector displays the low battery icon  **LOW** and activates the low battery alarm (beeps every 10 seconds if the confidence beep is disabled).

If the confidence beep option is enabled, the confidence beep stops if the battery power is low. For more information, refer to [Confidence Beep](#).

If the battery voltage is extremely low, the detector performs an automatic shutdown.

Datalogger Operation (optional)

The datalogger operation is automatic and requires no settings.

When the MultiMediaCard (MMC) is inserted in the detector, the MMC card icon  displays continuously while in normal operation mode.

The card is not required for operation; however, a warning message displays during activation as a reminder that the card is not inserted.

- **Error** - initially displays and **no dAtA cArD installed** then scrolls across the screen. After the message displays, the detector returns to normal operating mode. Insert the MMC card if required.

Deactivating the Detector

To deactivate the detector, complete the following:

Press  and hold until **OFF** displays (approximately 5 seconds).



The audible alarm beeps four times, the visual alarm flashes four times, and the detector vibrates.

Note



*If  is not held down until **OFF** displays, the detector will remain activated.*

Confidence Beep

The confidence beep is used to confirm that the detector is activated and the batteries have sufficient power to respond to a hazardous level of gas.

When battery power is sufficient, the audible alarm beeps twice every 15 seconds. The confidence beep stops when battery power is too low.

The confidence beep can be enabled or disabled. To enable/disable the confidence beep, complete the following:

Before activating the detector, press and hold . While holding , press .

As the start-up process begins, the confidence beep current mode changes.

Note

The LCD does not display confirmation to indicate the current mode of the confidence beep.

The normal activating/deactivating process does not automatically enable/disable the confidence beep. It remains in the selected mode until it is changed.



User Options Menu

The user options menu provides access to twenty-one user selections.

Note

Not all user options are available for detectors that do not have the datalogger feature.

To access the user options menu, complete the following:

1. To enter the user options menu, press  and  simultaneously and hold (approximately 5 seconds) until the LCD displays **USER OPTiOnS**.



Following the **USER OPTiOnS** screen, the **FinISh OPTiOnS** screen immediately displays.

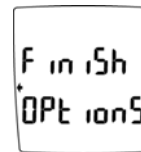



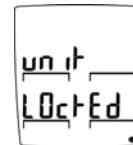

NOTE

*If the detector is pass code protected when **USER OPTiOnS** is entered, the LCD displays an error message.*



Refer to [Pass Code Protection](#) to enter a pass code.

2. Press  or  to scroll through the options. Press and hold  or  to scroll through the options quickly.
3. Press  to select a required option.
4. When the required activities have been performed for a selected option, the **FinISh OPTiOnS** screen automatically displays.

5. Use ▲ or ▼ to select another option if required.
6. To exit the user options menu and return to normal operation, use ▲ or ▼ to select **FinISh OPTioNS** and press ○.

The button indicator arrow(s) → display(s) on the LCD and points toward the button(s) that are available for additional activities. If additional activities cannot be performed for a selected option, the arrow(s) does not display.

Note

Using the ▲ pushbutton, the following user options are described in the order they display on the detector LCD.

Software Level

The software level provides information about the firmware and the EEPROM version of the detector.

To view information about the firmware and EEPROM version, complete the following:

From the user options menu, press Ⓣ.



For more information, refer to the [Specifications](#).

Finish Options

FinISh OPTioNS displays after accessing the **USER OPTioNS** menu, after each user option function is completed, and is used to exit the user options menu.

To exit the user options menu and return to normal operation, from the **FinISh OPTioNS** screen, press ○.

Latching Alarms

The **LATCHin ALArMS** option is used to set parameters for alarms, such as, an alarm persists until it is acknowledged by the user.

Note

The detector is shipped with the latching alarm option disabled.

In the event of an alarm condition, and if the low and high gas alarms are set to latch, the audible and visual alarms will persist until the alarm is acknowledged.

To enable/disable the latched alarm option, complete the following:

1. From the user options menu, use ▲ or ▼ to scroll to the **LAtch in ALArms** option.



2. Press ○ to select the option.

The LCD displays the current mode (**On** or **OFF**) and then returns to the **Finish OptionS** screen.

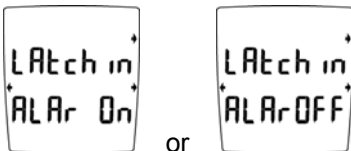

3. Use ▲ or ▼ to scroll to a new user option, or press ○ to exit user options and return to normal operating mode.

Safe Display

The **SAFE DISPLAY** option automatically notifies that only normal ambient conditions exist and that there are no gas hazards monitored. This option can be enabled or disabled.

If this option is enabled, when the detector is in normal operating mode and when no hazards are measured, **SAFE** scrolls across the LCD continually.

SAFE does not display while functions are being performed.

Note

This option is automatically disabled in stealth mode.

If any gas is present, such as

- readings are other than zero for toxic combustible gas(es), or
- the oxygen reading is other than 20.9%,

the LCD displays the gas levels for all of the sensors. When the levels return to normal, **SAFE** again scrolls across the screen.

To enable/disable the safe display option, complete the following:

1. From the user options menu, use ▲ or ▼ to scroll to the **SAFE dISPLAY** option.



2. Press ○ to select this option.

The LCD displays the current mode (**On** or **OFF**) and then returns to the **FinISh OPTioNS** screen.

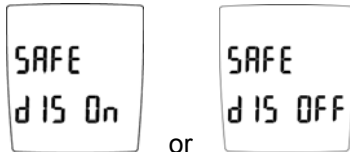

3. Use ▲ or ▼ to scroll to a new user option, or press ○ to exit user options and return to normal operating mode.

Combustible Sensor Measuring Selection

The **LEL SEn unitS** option is used to select how the measurements are displayed. The options are 0-100% LEL or 0-5.0% vol.

Note

The detector is shipped with the combustible sensor set to measure and display combustible gases in the 0-100% LEL (lower explosive limit) range.

The detector can be set to measure and display methane in the 0-5.0% by volume range.

Note

Percent by volume measurements apply to methane only.

To change the combustible sensor unit of measure, complete the following:

1. From the user options screen, use ▲ or ▼ to scroll to the **LEL SEn units** option.

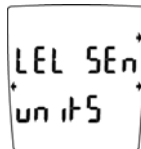

2. Press ○ to select the option.

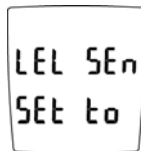

An LEL current mode screen immediately displays either vol or %.

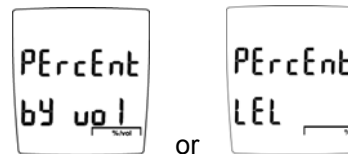

PErcEnt by vol – units are displayed by volume.

PErcEnt LEL – units are displayed by percent.

The LCD returns to the **FinISh OPTionS** screen.

3. Use ▲ or ▼ to scroll to a new user option, or press ○ to exit user options and return to normal operating mode.

French

The **AFFiche FrAnc** option is used to convert all of the LCD screens to display French text.

1. From the user options menu, use ▲ or ▼ to scroll to the **AFFiche FrAnc** option.



2. Press ○ to select the option.

The LCD automatically displays French text and returns to the **FinISH OPTioNS** screen.

3. Use ▲ or ▼ to scroll to a new user option, or press ○ to exit user options and return to normal operating mode.

German

The **AnZEigE dEutSch** option is used to convert all of the LCD screens to display German text.

1. From the user options menu, use ▲ or ▼ to scroll to the **AnZEigE dEutSch** option.

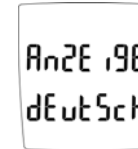

2. Press ○ to select the option.

The LCD automatically displays German text and returns to the **FinISH OPTioNS** screen.

3. Use ▲ or ▼ to scroll to a new user option, or press ○ to exit user options and return to normal operating mode.

Spanish

The **FiJAR A ESPAnoL** option is used to convert all of the LCD screens to display Spanish text.

1. From the user options menu, use ▲ or ▼ to scroll to the **FiJAR A ESPAnoL** option.



2. Press ○ to select the option.

The LCD automatically displays Spanish text and returns to the **FinISh OPTioNS** screen.

3. Use ▲ or ▼ to scroll to a new user option, or press ○ to exit user options and return to normal operating mode.

Portuguese

The **AdJuStE Portugu** option is used to convert all of the LCD screens to display Portuguese text.

1. From the user options menu, use ▲ or ▼ to scroll to the **AdJuStE Portugu** option.

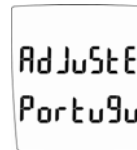

2. Press ○ to select the option.

The LCD automatically displays Portuguese text and returns to the **FinISh OPTioNS** screen.

3. Use ▲ or ▼ to scroll to a new user option, or press ○ to exit user options and return to normal operating mode.

English

The **SEt to EngLiSh** option is only available when the LCD displays text in French, German, Spanish, or Portuguese.

1. Use ▲ or ▼ to scroll to the **SEt to EngLiSh** option.

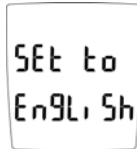

2. Press ○ to select the option.

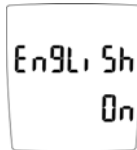

The LCD automatically displays English text and returns to the **FinIsh OPTioNS** screen.

3. Use ▲ or ▼ to scroll to a new user option, or press ○ to exit user options and return to normal operating mode.

Sensor Options

The sensor options are used to temporarily disable a sensor and the corresponding fail alarm.

The detector will continue to function normally. The disabled sensor can be enabled again at any time. The sensor should be replaced and enabled as soon as possible.





⚠ Warning

Disabling an installed sensor configures the detector to a 1, 2, or 3-gas unit. No protection is provided for the gas targeted by the selected sensor(s). Disabling a sensor should only be performed with extreme caution.

To enable/disable a sensor, complete the following procedures:

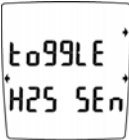
Note

*The following procedures example refers to the **toggle H2S SEn** option. The procedures are the same for all of the sensors.*

	<p>toggLE H2S SEn (hydrogen sulfide sensor)</p>
	<p>toggLE CO SEn (carbon monoxide sensor)</p>
	<p>toggLE LEL SEn (combustible)</p>
	<p>toggLE O2 SEN (oxygen sensor)</p>
<p style="text-align: center;"><i>Note</i></p> <p>For the toggLE O2 CAL option, refer to Automatic Oxygen Calibration.</p>	

The sensor options available to select from are as follows:

To enable/disable the H₂S sensor, complete the following:

1. From the user options menu, use ▲ or ▼ to scroll to the **toggLE H2S SEn** option.

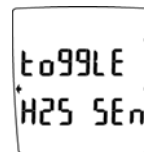

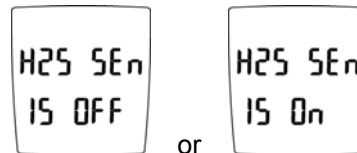

2. Press ○ to select the option.



The LCD displays the current mode (**On** or **OFF**) and then returns to the **FiniSh OptionS** screen.

If all of the sensors are disabled, the following message displays: **ALL SEnSorS ArE diSAbLEd - ALL SEnSorS ArE rESEt to on.**

If a sensor option is enabled on the LCD but the new sensor is not installed on the detector, the following message displays: **H2S SEnSor not inStALLEd - SEnSor CANNOT bE EnAbLEd.**

3. Use  or  to scroll to a new user option, or press  to exit user options and return to normal operating mode.

Pass Code Protection

The **PASS Lock** option is used to prevent access to the user options and calibration/alarm setpoint procedure without a pass code.

Note

For calibration, the pass code is requested after auto zero is performed (if enabled).



If the detector is pass code protected, the key icon () displays at the bottom of the LCD during start-up.

Note

The detector is shipped with the pass code protection option disabled.

Enable/Disable Pass Code Protection

To enable/disable the pass code protect option, complete the following:

1. From the user options menu, use  or  to scroll to the **PASS Lock** option.



2. Press  to select this option.

The detector emits two beeps and the LCD displays if pass code protection is enabled or disabled.

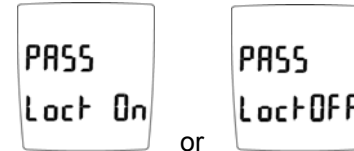

The LCD displays the current mode (**On** or **OFF**) and then returns to the **FinISh OPTioNS** screen.

Note

The pass code is provided on a separate card inside the shipping container.

Entering the Pass Code

If the pass code protected option is enabled and access to the user options menu or calibration is attempted, the LCD displays the following:

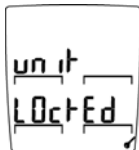

The LCD then immediately prompts for the pass code. The following three screens display.

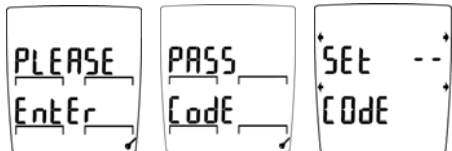

To enter the pass code, complete the following:

1. From the **SEt-- COdE** screen, use ▲ or ▼ to scroll to the correct pass code.
2. Press ○ to confirm the pass code selection.
3. If the pass code is correct, access is granted and the LCD automatically displays the **FinIsh OPTiOnS** screen. Use ▲ or ▼ to scroll to the required user option(s).

If the pass code is incorrect or the correct pass code is not confirmed within 10 seconds, the LCD displays an error message.

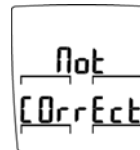

The detector returns to normal operating mode for an incorrect pass code.

For a correct pass code not confirmed within 10 seconds, the following error messages displays.

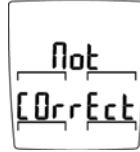

The detector then returns to normal operating mode.

4. Repeat steps 1-2. If the second attempt is unsuccessful, confirm that the pass code is correct.

Automatic Oxygen Calibration

The **toggLE O₂ CAL** is used to enable/disable oxygen (O₂) automatic calibration that is performed during start-up.

Note

The detector is shipped with the automatic O₂ calibration option enabled.

To enable/disable the automatic O₂ calibration option, complete the following:

1. From the user options menu, use ▲ or ▼ to scroll to the **toggLE O₂ CAL** option.

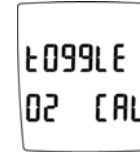

2. Press ○ to select the option.

The LCD displays the current mode (**On** or **OFF**) and then returns to the **FinisH OPTioNS** screen.

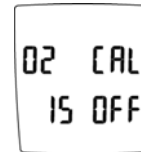

or

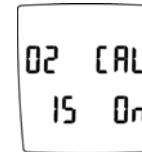

3. Use ▲ or ▼ to scroll to a new user option, or press ○ to exit user options and return to normal operating mode.

Span Concentration

The **Set CAL SPAnS** option is used to enter each sensor's span concentration value that is required for calibration.

Note

BW recommends that span concentration values be set between specific ranges. Refer to [Calibration and Setting Alarm Setpoints](#).

To modify the span concentration values, complete the following:

1. From the user options menu, use ▲ or ▼ to scroll to the **SEt CAL SPAnS** option.



2. Press ○ to select and access the span concentration values screen.
3. The **H₂S** value is automatically selected to modify. Use ▲ or ▼ to scroll to the required value.

	H₂S Hydrogen sulfide
	CO Carbon monoxide
	LEL Lower explosive limit

Note

*The span concentration values can only be modified in the order they are presented in this table. To bypass any concentration value, press ○ to confirm and automatically proceed to the next value. Press ○ to confirm the new value and automatically proceed to the **CO** value.*

Note

*If a new value is not confirmed within 10 seconds, an **Err** message replaces the selected value. The previous value then displays and the detector automatically proceeds to the next concentration value.*

To bypass the **H₂S** value, only press ○. The detector automatically accepts the current value and then proceeds to the **CO** value.

4. For the remaining values repeat step 3 to modify or bypass.

- When each of the span concentration values have been accepted, the LCD returns to the **FinISh OptionS** screen.
- Use ▲ or ▼ to scroll to a new user option, or press ○ to exit user options and return to normal operating mode.

STEL Calculation Period

The **StEL PERiod** option is used to adjust the short-term exposure limit (STEL) calculation period (5-15 minutes).

Note

The detector is shipped with the STEL calculation period set to 15 minutes.

To change the STEL calculation period, complete the following:

- From the user options menu, use ▲ or ▼ to scroll to the **StEL PERiod** screen.

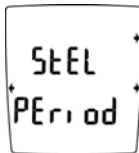

Press ○ to select **StEL PERiod** and to access the STEL time period screen.

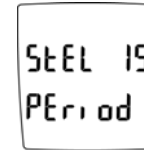

- Use ▲ or ▼ to scroll to the required time period value (**5-15**). Press ○ within 10 seconds to save the new period change.

The LCD returns to the **FinISh OptionS** screen.

Note

If the new value is not entered and confirmed within 10 seconds, the LCD displays an error message.

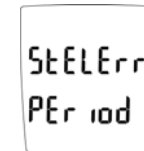

- Use ▲ or ▼ to scroll to a new user option, or press ○ to exit user options and return to normal operating mode.

Stealth Mode

The **StEAItH** mode option is designed to ensure that the GasAlertMicro is undetected in situations that require concealment. This option is used to disable the

- audible alarms,
- visual alarms, and
- backlight.

Only the vibrate alarm remains enabled.

Note

The detector is shipped with the stealth mode disabled.

To enable/disable the stealth mode, complete the following:

1. From the user options menu, use ▲ or ▼ to scroll to the **StEAItH** option.



2. Press ○ to select this option.

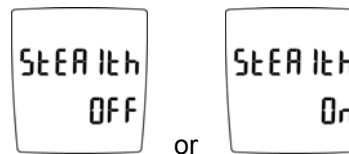

The LCD displays the current mode (**On** or **OFF**) and then returns to the **FinIsh OPTioNS** screen.

3. Use ▲ or ▼ to scroll to a new user option, or press ○ to exit user options and return to normal operating mode.

Automatic Backlight

The **Auto bAcklit** option is used to enable or disable the automatic backlight of the detector. When enabled, press any button to activate the backlight for 10 seconds, regardless of the lighting condition.

Note

The detector is shipped with the automatic backlight option enabled.

Backlight does not operate while in stealth mode.

To enable/disable the backlight, complete the following:

1. From the user options menu, use the ▲ or ▼ to scroll to the **Auto bAcklit** option.



2. Press ○ to accept the option.

The LCD displays the current mode (**On** or **OFF**) and then returns to the **FinISh OPTioNS** screen.

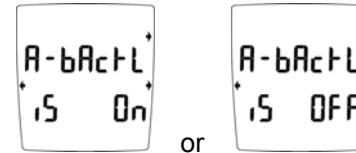

3. Use ▲ or ▼ to scroll to a new user option, or press ○ to exit user options and return to normal operating mode.

MicroBatt Mode

The **micro-bAt** option verifies if the detector is using the GA MicroBatt battery. The detector provides an **On** or **OFF** option to choose between lower MicroBatt levels and normal battery levels.

Note

If the detector is equipped with the rechargeable battery, BW highly recommends that the MicroBatt option be enabled. The MicroBatt factory default setting is disabled.

To enable the MicroBatt mode, complete the following:

1. From the user option menu, use ▲ or ▼ to scroll to the **micro-bAt** option.



2. Press ○ to select this option.

The detector beeps twice. The LCD displays the current mode (**On** or **OFF**) and then returns to the **FinISh OPTiONS** screen.

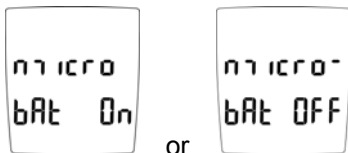

3. Use ▲ or ▼ to scroll to a new user option, or press ○ to exit user options and return to normal operating mode.

Bump Due Reminder

The **bunP duE** option is used to display a reminder during startup if a bump test has not been performed within the previous 24 hours.

Note

The detector is shipped with the bump due reminder option disabled.

The bump test function can only be performed using the MicroDock II Automatic Test and Calibration Station. Refer to the *MicroDock II User Manual* for detailed information.

To enable/disable the bump due reminder option, complete the following:

1. From the user options menu, use ▲ or ▼ to scroll to the **bunP duE** option.



2. Press ○ to select this option.

The LCD displays the current mode (**On** or **OFF**) and then returns to the **FinISh OPTioNS** screen.

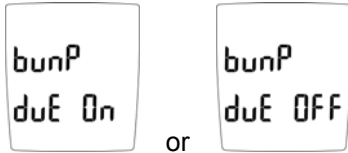

- Use ▲ or ▼ to scroll to a new user option, or press ○ to exit user options and return to normal operating mode.

Adjust Clock

AdJuSt CLock is used to adjust the weekday (1-7), time (hour/minute), and date (day/month/year) of the detector.

To change the time and/or date, complete the following:

- From the user options menu, use ▲ or ▼ to scroll to the **AdJuSt CLock** option.



- Press ○ to accept the option and access the date/time screen.

<p>The image shows a square LCD screen with '2 20:16' on the top line and '220602' on the bottom line. There are small arrows on the right and left sides of the screen, indicating scrollable options.</p>	:16 Minute
	20: Hour
	2 Day of the week Monday = 1, Tuesday = 2, Wednesday = 3 etc.
	22 Day of the month
	06 Month
	02 Year
<p><i>Note</i></p> <p><i>The weekday, time, and date values can only be changed in the order they are presented in this table. To bypass any setting, press ○. The detector automatically retains the current value and advances to the next time/date option.</i></p>	

- The minutes are automatically selected. Use ▲ or ▼ to scroll to the required value. Press ○ to confirm the new value and automatically advance to the hour option.

To bypass the minute options, only press \circ . The detector automatically retains the current value and advances to the hour option.

4. For the remaining time and date options, repeat step 3 to change or accept the current value.
5. When each of the time and date values have been accepted, the LCD returns to the **FinISh OptionS** screen.
6. Use \blacktriangle or \blacktriangledown to scroll to a new user option, or press \circ to exit user options and return to normal operating mode.

Logger Rate

LoggEr rAtE is used to determine how often data is recorded to the MMC card. The logger rate value ranges from 1-127 seconds.

Note

The datalogger is factory set to record a sample every 5 seconds.

To adjust the datalogger sampling rate, complete the following:

1. From the user options menu, use \blacktriangle or \blacktriangledown to scroll to the **LOGgEr rAtE** option.

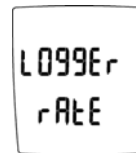

2. Press \circ to accept this option.

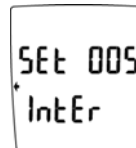

3. To change the sampling rate, use \blacktriangledown or \blacktriangle to scroll to the required sample rate value and press \circ to confirm the new value.

The LCD automatically returns to the **FinISh OptionS** screen.

Note

*If a new sample rate is not selected and confirmed within 10 seconds, the detector automatically exits the **SEt 005 IntEr** screen and displays the **FinISh OptionS** screen.*

Alarms

Table 6 provides information about the detector alarms and includes an example of each LCD screen as it appears when it is in an alarm state.

Table 7 provides information about the computed gas exposures.

During an alarm condition, the LCD activates the backlight and displays the current ambient gas reading.

If more than one type or level of alarm exists at the same time, a multi-gas alarm occurs.

To change the factory-set alarm setpoints, refer to the section [Calibration and Setting Alarm Setpoints](#).

Table 6. Alarms

Alarms	Display	Alarms	Display
<p>Low Alarm:</p> <ul style="list-style-type: none"> • Slow tone and flash • ALARM and target gas bar flash • Vibrator alarm activates 		<p>High Alarm:</p> <ul style="list-style-type: none"> • Fast tone and flash • ALARM and target gas bar flash • Vibrator alarm activates 	
<p>STEL Alarm:</p> <ul style="list-style-type: none"> • Fast tone and flash • ALARM and target gas bar flash • Vibrator alarm activates 		<p>TWA Alarm:</p> <ul style="list-style-type: none"> • Slow tone and flash • ALARM and target gas bar flash • Vibrator alarm activates 	

Table 6. Alarms (cont.)









Alarms	Display	Alarms	Display
<p>Multi-Gas Alarm</p> <ul style="list-style-type: none"> • Alternating low and high alarm tone and flash • ALARM and target gas bars flash • Vibrator alarm activates 		<p>Over Range Alarm: (Over Level Exposure)</p> <ul style="list-style-type: none"> • Fast tone and flash • ALARM and target gas bar flash • Vibrator alarm activates 	
<p>Sensor Alarm:</p> <ul style="list-style-type: none"> • Slow tone and flash • ALARM and gas bar(s) flash • Vibrator alarm activates 		<p>Confidence Beep:</p> <ul style="list-style-type: none"> • two fast beeps every 15 seconds. 	

Table 6. Alarms (cont.)

Alarms	Display	Alarms	Display
<p>Automatic Shutdown Alarm:</p> <ul style="list-style-type: none"> • eight beeps and flashes •  LOW displays periodically • Vibrator alarm temporarily activates 		<p>Normal Shutdown:</p> <ul style="list-style-type: none"> • four beeps and flashes • Vibrator alarm temporarily activates 	
<p>Low Battery Alarm: (Confidence beep disabled)</p> <ul style="list-style-type: none"> • one beep and one flash every 10 seconds •  LOW flashes 			

Gas Exposures Computed

⚠ Warning

To avoid possible personal injury, do not deactivate the detector during a work shift. TWA and STEL readings reset if the detector remains off for more than 5 minutes.

Table 7. Computed Gas Exposures

Gas Exposure	Description
TWA (CO, SO ₂ , and H ₂ S only)	Time-weighted average based on an 8-hour workday. Accumulated value.
STEL (CO, SO ₂ , and H ₂ S only)	Short-term exposure level based on a 5-15 minute period (user defined). Accumulated value.
Maximum* (Peak)	Maximum gas exposures encountered during a work shift.
* For oxygen, maximum concentration encountered of either very high or very low levels.	

Viewing Gas Exposures

The detector computes the TWA value based on an 8-hour workday and the STEL alarm is based upon a 5 to 15 minute period (user defined). For additional information and procedures, refer to [STEL Calculation Period](#).

Press until the LCD displays the TWA gas exposures and then the STEL gas exposures.

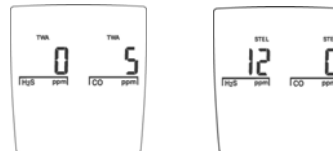

Lastly, the LCD displays the maximum gas exposures.

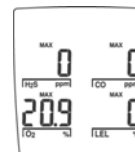

To clear the TWA, STEL, and maximum gas exposure readings, press and simultaneously.

Gas Alarm Setpoints

The gas alarm setpoints trigger the gas alarms, which are described in the following table.

Table 8. Gas Alarm Setpoints

Alarm	Condition
Low Alarm	CO, H ₂ S, SO ₂ , and combustibles: Ambient gas level above the low alarm setpoint. (For O ₂ refer to the statement following this table).
STEL and TWA Alarms (CO, SO ₂ and H ₂ S only)	Accumulated value above the STEL or TWA alarm setpoints.
High Alarm	CO, H ₂ S, SO ₂ , and combustibles: Ambient gas level above the high alarm setpoint. (For O ₂ refer to the statement following this table).
Multi-Gas Alarm	Two or more gas alarm conditions.

Oxygen alarm setpoints: User defined for low and high alarms. Set both below, both above, or one above and one below 20.9%, as desired.

Resetting Gas Alarm Setpoints

Note

Standard factory alarm setpoints will vary by region.

Occupational Safety and Health Association (OSHA) standard settings are used as an example.

Table 9. Sample Factory Set Alarm Setpoints

Gas	TWA	STEL	Low	High
CO	35 ppm	50 ppm	35 ppm	200 ppm
H ₂ S	10 ppm	15 ppm	10 ppm	15 ppm
O ₂	N/A	N/A	19.5%	23.5%
Combustibles	N/A	N/A	10% LEL	20% LEL
SO ₂	10 ppm	15 ppm	10 ppm	15 ppm

To change the factory set alarm setpoints, refer to [Calibration and Setting Alarm Setpoints](#).

Note

An alarm can be disabled by setting the alarm setpoint to zero.

Stopping a Gas Alarm

The low and high alarms stop when the ambient gas level returns to the acceptable range.

Note

If alarms are set to latch, press to reset the alarms.

Sensor Alarm

The detector tests for a missing or defective sensor during the activation self-test. Refer to [Troubleshooting](#).

Low Battery Alarm

The detector tests the batteries upon activation and continuously thereafter. Battery power continually displays during normal operation. If the battery voltage is low, the detector activates the low battery alarm.

The low battery alarm continues until the batteries are replaced, or the battery power is almost depleted. If the battery voltage drops too low, the detector performs an automatic shutdown.

Automatic Shutdown Alarm

If the battery voltage is in immediate danger of dropping below the minimum operating voltage, the audible alarm beeps eight times, the visual alarm flashes eight times, and the LCD displays **OFF**.

Note

In stealth mode, the detector only vibrates before shut-down.

To replace the batteries, refer to [Replacing the Batteries](#).

Calibration and Setting Alarm Setpoints

Calibration Guidelines

When calibrating the detector adhere to the following guidelines:

- Recommended gas mixture:
CO: 10 to 500 ppm balance N₂
H₂S: 10 to 100 ppm balance N₂
SO₂: 10 to 100 ppm balance N₂
LEL: 10 to 100% LEL or 0.5 to 5% by vol. methane balance air
O₂: Clean air, 20.9 %
- CG-Q58-4 and CG-Q34-4 calibration gas (4-gas mix) are available from BW Technologies. Refer to [Replacement Parts and Accessories](#).
- Calibration accuracy is never better than the calibration gas accuracy. BW Technologies recommends a premium-grade calibration gas. Gases with National Institute of Standards and Technology (NIST) traceable accuracy improve the validity of the calibration. Do not use a gas cylinder beyond its expiration date.

- Calibrate a new sensor before use. Install the sensor, activate the detector, and allow the sensor to stabilize before starting calibration (used: 60 seconds; new: 5 minutes).
- Calibrate the detector on a regular basis, depending upon use and sensor exposure to poisons and contaminants. BW recommends at least once every 180 days (6 months).
- Calibrate the detector if the ambient gas display varies at start-up (readings are above or below zero).
- It is advisable to calibrate the sensor before changing the alarm setpoints.
- Calibrate only in a clean atmosphere that is free of background gas.
- To disable an alarm, set the corresponding alarm setpoint to zero.
- The combustible sensor is factory calibrated from 0-100% LEL using methane. If monitoring a different combustible gas in the 0-100% LEL range, calibrate the sensor using the appropriate gas.
- The oxygen sensor can be automatically calibrated each time upon activation (if this feature is enabled). Activate the detector in a normal (20.9% oxygen) atmosphere.
- If a certified calibration is required, contact [BW Technologies](#).
- Prior to calibration or a bump test, the detector must stabilize after activation for 1 minute.

Diagnostics Protection

The detector tests the ambient air (Auto Zero) and the test gas that is applied (Auto Span) to ensure it meets expected values.

In auto span, if any target gas is not present or does not meet expected values, the LCD will display an error message and exit calibration mode. The previous value(s) will be retained.

Attaching the Gas Cylinder to the Detector

The calibration hose that is shipped with the detector simplifies the sensor testing and calibration processes.

Refer to the following table and figure for installation information.

Table 10. Attaching the Gas Cylinder to the Detector

Item	Description
1	Detector and calibration cap
2	Calibration hose
3	Regulator and gas cylinder

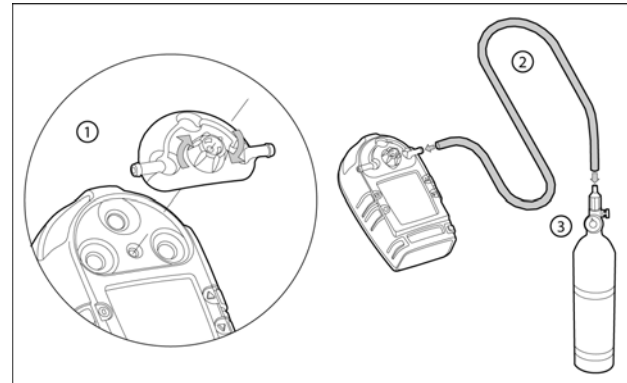

Figure 4. Attaching the Gas Cylinder to the Detector

Note

Only use the calibration cap during the calibration process.

Calibration Procedures

The calibration process requires several functions, some of which can be bypassed. A note is added to each option that can be bypassed.

Note

Verify that the calibration gas being used matches the span concentration value(s) that are defined for the detector. For more information, refer to [Span Concentration](#).

The following procedures for calibration and setting alarm setpoints are listed in the same order as they display on the detector. They are as follows:



- Start Calibration
- Auto Zero and Oxygen (O₂) Sensor Calibration
- Pass Code Protect Activated
- Auto Span
- Alarm Setpoints
- Setting the Calibration Due Date

Start Calibration

Note

To bypass calibration, at any time after auto zero press . The detector retains all saved values and the audible alarm beeps four times before the detector proceeds to the alarm setpoint screens.

To begin the calibrate/set alarm setpoints process, complete the following:

1. Ensure the following procedures are performed in a clean atmosphere.
2. From normal operating mode, press and hold  and  until the calibration screen displays.



The detector beeps four times and the auto zero screen immediately displays.



Auto Zero



Sensor Fail



Note

Do not apply the calibration gas until the LCD displays .

Auto Zero and Oxygen (O₂) Sensor Calibration

Note

At any point after the auto zero but before calibration gas is detected, press  to bypass calibration and proceed to the alarm setpoints.

The auto zero automatically zeros the toxic sensors and calibrates the O₂ sensor.

- The LCD flashes **Auto Zero** and the audible alarm beeps twice while the detector zeroes the toxic sensors, and then calibrates the oxygen sensor.

Pass Code Protect Activated

After a successful auto zero and if the detector is pass code protected, the LCD prompts for the pass code.

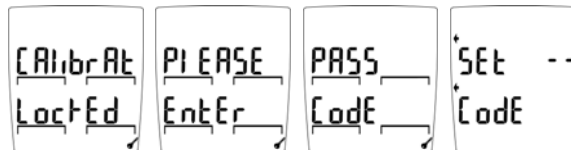

The pass code must be entered before proceeding to auto span and alarm setpoints.

- Use  or  to scroll to the correct pass code.

Press to confirm the pass code and to proceed to the auto span.

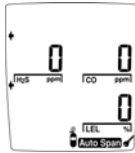

Note

Do not apply the calibration gas until  displays.

Auto Span

Note

Press to bypass the calibration and proceed to alarm setpoints.

- When the LCD displays , attach the calibration cap and apply the gas to the sensor at a flow rate of 250 to 500 ml/min.

The auto span function begins calibrating the gases (maximum four). The audible alarm beeps once when the detector senses a sufficient gas concentration.

The detector then spans the sensor(s) for approximately 2 minutes. When the span is complete, the audible alarm beeps three times.

- Remove the calibration gas.

Auto Span Successful

If the calibration is successful, the following screen displays.



The LCD then displays the alarm setpoints screen.

If the span adjustment is large (more than 20%), the LCD displays a warning message: **SPAn AdJuSt unuSuALLY LArgE - chEck thAt thE cAL gAS IS cOrrEct.**

The following screens also display:

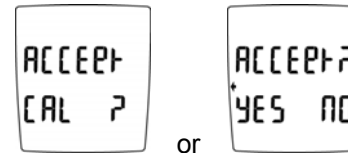

- Press **YES** to accept the calibration or press **NO** to reject the values.

GasAlertMicro

User Manual

If a span is rejected, the LCD displays: **Note: SPAN rEJECTEd** and bypasses the span for the failed sensor(s).

The LCD then automatically proceeds to the alarm setpoints screen.

Auto Span Fail

If one or more of the sensors fail, an error message displays indicating which sensor failed.

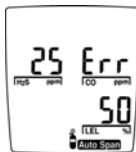

The remaining sensors continue to span normally.

If the auto span still fails, confirm that

- gas is being applied to the sensor,
- the sensor is detecting a sufficient gas concentration within 30 seconds, and
- the gas concentration does not drop significantly during the 2-minute span.

Attempt the auto span calibration again.

If the auto span is still unsuccessful, attach a new gas cylinder.

If the sensor fails the span again, replace the sensor. Refer to [Replacing a Sensor or Sensor Filter](#).

Alarm Setpoints

The alarm setpoints are used to set limits and ranges for the TWA, STEL, low, and high alarms.

	H₂S (Hydrogen sulfide)
	CO (Carbon monoxide)
	LEL % / vol (lower exposure limits)
	O₂ % (Oxygen 20.9 percent))
The LCD displays the TWA, STEL, low, and high alarm setpoints for H ₂ S first. After H ₂ S, it automatically proceeds to CO and then the remaining gases, displaying the alarm setpoints for each.	

Note

The alarm setpoints can be modified only in the order they are presented in this table. To bypass any alarm setpoint, press \bigcirc to retain the current value and automatically proceed to the next alarm setpoint.

Note

Alarms may be set at any point within the detection range for the sensor. Refer to [Specifications](#) or set the alarm setpoint to zero to disable a sensor. Factory alarm setpoints may vary by region.

Setting the TWA Alarm Setpoint

The TWA alarm setpoint for H₂S gas immediately displays after the auto span, regardless if the span was successful or not.



8. Use \blacktriangle or \blacktriangledown to select a new TWA alarm set point value for H₂S and press \bigcirc to confirm the new value.

Or

To bypass the STEL alarm setpoint, press only \bigcirc to retain the current value and proceed to the low setpoint.

Note

If the new alarm setpoint is not confirmed within 10 seconds, the detector displays **Err** and automatically retains the previous alarm setpoint.

Setting the STEL Alarm Setpoint

The **STEL** alarm setpoint displays automatically after the **TWA** alarm setpoint.



9. Use \blacktriangle or \blacktriangledown to select a new STEL alarm setpoint value for H₂S and then press \bigcirc to confirm the new value.

Or

To bypass the STEL alarm setpoint, press only to retain the current value and proceed to the low setpoint.

Setting the Low Alarm Setpoint

The low alarm setpoint displays automatically after the **STEL** alarm setpoint.



10. Use or to select a new low alarm setpoint value and then press to confirm the new value.

Or

To bypass the low alarm setpoint, press only to retain the current value and automatically proceed to the high alarm setpoint.

Setting the High Alarm Setpoint

The high alarm setpoint displays automatically after the low alarm setpoint.



11. Use or to select a new high alarm setpoint value for H₂S and then press to confirm the new value.

Or

To bypass the high alarm setpoint, press only to retain the current value and automatically proceed to the TWA alarm setpoint for CO.

Setting the Remaining Alarm Setpoints

- Repeat steps 8-10 to set the alarm setpoints for each remaining sensor.

The audible alarm beeps four times when the alarm setpoint function is complete. The detector then proceeds to the **CAL duE** screen.

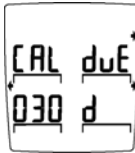

Setting the Calibration Due Date

The calibration due date is designed to automatically display the number of days remaining before calibration is due to be performed.

The **CAL duE** screen automatically displays how many days are remaining during the self-test process. The calibration due date option allows from 1-365 days to be set as the default value. BW recommends that the detector be calibrated at least once every 180 days (6 months).

Note

The detector is shipped with the factory default setting of 180 days.

Successful Calibration

When the sensors are successfully calibrated, the calibration due date automatically resets to the previous entered setting.

To change the default number of days remaining before calibration is due, complete the following:

- From the **CAL due** screen, use ▲ or ▼ to scroll to a new value (1-365).
- Press ○ to confirm the new value. The new value becomes the default value. The detector then beeps five times and returns to normal operation.

Note

If a new value is not confirmed within 10 seconds, the detector automatically retains the previous calibration due date.

Unsuccessful Calibration

The calibration due date cannot be set unless all sensors successfully span.

If the calibration is unsuccessful, or if calibration is due but is not performed, the following error message displays and scrolls across the bottom of the LCD.

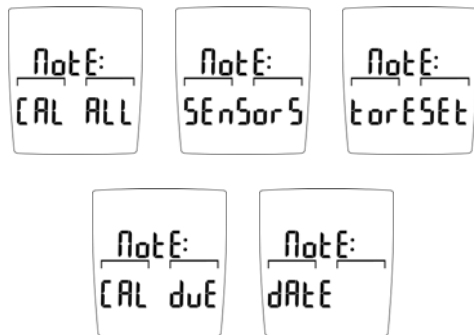

Verification

After calibration is complete and the detector is in normal operating mode, test the detector by using a gas cylinder other than the one used in calibration. The gas concentration should not exceed the sensor's detection range. Verify that the detector LCD displays the expected concentration.

MultiMediaCard (MMC)

A standard 32MB MMC Flash Memory card is supplied with the detector. When purchasing additional MultiMediaCards, BW Technologies recommends MMC Flash Memory cards that contain between 32 MB and 128 MB storage capacity.

MultiMediaCard(s) compatible with the MMC specification always has the exact word "MultiMediaCard" or "MMC" written on the disk or package. Cards that do not contain these exact words are not a MultiMediaCard.

The MMC card is not the same as the following:

- MultiMedia card
- Multi media card
- SmartMedia
- CompactFlash
- Memory Stick

MMC cards are available through retailers throughout the world. They are also available via mail order and Internet vendors.

MultiMediaCard Troubleshooting

The following error message scrolls on the LCD during start-up if the MMC card is not inserted.



The card is not required for operation. The error message displays as a reminder.

A new MMC card is automatically formatted during start-up when it is inserted into the detector. The LCD displays the following message before the detector begins formatting.

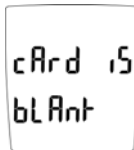

Recovering Data Files

If the MMC card is reformatted or erased accidentally by the computer application, the recorded data file can be recovered.

Ensure the card is inserted correctly in the card reader. If the recorded data file is not visible, ensure the following:

- The card reader is visible in the **My Computer** window.
- If not, verify that the card reader is installed correctly and that the connections are secure.
- In the Removable Disk drive window, verify that **All Files** is selected in the file types field.

Place the MMC card back into the detector. When the detector reformats part of the card it should be visible.

If the data file **LOGFILE0.CSV** is still not visible, format the MMC card in Windows and then complete the following:

1. Remove the MMC card from the card reader.
2. Insert the MMC card into the detector and allow the detector to reformat part of the MMC.
3. Remove the MMC card from the detector and insert it back into the card reader.
4. From the computer, double-click on **My Computer**.
5. Select the drive that corresponds to the card reader.
6. The recorded data file **LOGFILE0.CSV** should be visible.

7. If the recorded data file is still not visible, insert the MMC card back into the detector and then activate the detector. The LCD will display the following message:

Error. dAtA fiLE hAS bEEEn dELEtEd. The options to erase or to restore data then display

8. **rEStorE**

Use **▲** and **▼** to select **rEStorE** and press **○** to confirm the selection.

The detector restores the data to the MMC card and resumes the start-up procedure.

ErASE

Use **▲** and **▼** to select **ErASE** and press **○** to confirm the selection.

The LCD displays **ArE You SurE?**

Note

Once data is erased it cannot be retrieved.

Press **○** to confirm or press **Ⓢ** to abort.

If **○** is pressed, all data will be erased.

If **Ⓢ** is pressed, the LCD will display the following message:

NotE: CArd CAnnot bE uSEd PuLL out CArd to ContinuE.

Insert a new card or erase the data. The detector then resumes normal operation.

Direct Import to Compatible Programs

Note

Information from this point on applies only to users who are not using the Excel Datalog Manager (EDM) or Fleet Manager. The following information applies to direct data import into Excel and other compatible programs.

To view the datalogger data, complete the following:

1. Access a spreadsheet, database, word processor, or text editor application. Examples of these applications are as follows:
 - Microsoft® Excel 95, 98, and 2000,
 - Quattro Pro,
 - Lotus 1-2-3,
 - Microsoft® Access, and
 - Microsoft® Word.

Note

Word processors and text editors may also be used. However, performance may be poor since the datalogger file is at least 32 MB in size.

2. Insert the MMC card into the card reader and open the **LOGFILE0.CSV** file.

The data for user-accessible models is provided in comma-separated-value (CSV) format. The data displays in the following order:

- Date, day, time;
- H₂S, CO, LEL, O₂;
- H₂S TWA, CO TWA; and
- status codes, serial number.

The recorded data includes eight single-character unit status codes. The eight characters represent codes for the H₂S, CO, LEL, and O₂ sensors, datalogger, unit battery status,

and unit alarm status. A summary of most of the available codes can be seen in the following Table 11.

Determining Application Compatibility

To determine if the selected application is compatible, complete the following:

1. Insert the MMC card into the card reader.
2. Open the selected application.
3. Use the application's **File>Open** menu option to locate and open the data file.

If the recorded data file is compatible with the application, it automatically opens. If it is not, an error message displays.

Note

Some applications have an internal file size limit and may not load the entire file. Check the application's specifications prior to use.

Table 11. Datalogger Status Codes

General Codes					
—	Normal operation	G	Backlight is on		
Sensor Codes					
L	Low alarm	v	Dual alarm (high and STEL alarms)	1	Alarm setpoint 1 (low alarm)
H	High alarm	w	Dual alarm (TWA and STEL alarms)	2	Alarm setpoint 2 (high alarm)
T	TWA alarm	x	Triple alarm (TWA, STEL, and low)	3	Alarm setpoint 3 (TWA alarm)
U	Dual alarm (low and TWA alarms)	y	Triple alarm (TWA, STEL, and high)	4	Alarm setpoint 4 (STEL alarm)
V	Dual alarm (high and TWA alarms)	O	Sensor is over-ranged	D	Calibration due date (in days)
s	STEL alarm	C	Calibrating	E	Last calibration (in days)
u	Dual alarm (low and STEL alarms)	F	Sensor Failure	Z	Auto zeroing
Battery Status Codes					
—	Batteries OK	B	Low battery alarm	K	Confidence beep is active
Alarm Status Codes					
L	Low alarm	M	Multi-gas alarm	S	Automatic shutdown
H	High alarm	C	Calibration	F	Self-test fail
T	TWA alarm	Q	Manual shutdown	R	Real-time clock failure

TWA readings greater than 99 are recorded as over limit (OL). When datalogger information is imported into most spreadsheet software, it will appear similar to the example provided below. Line numbers are included in this example for clarity.

Table 12. CSV File Example

Line	Date (dd-mm-yy)	Day (Mon=1)	Time (hh:mm:ss)	H ₂ S (ppm)	CO (ppm)	LEL (%LEL)	O ₂ (%)	H ₂ S TWA (ppm)	CO TWA (ppm)	Unit Status	Serial Number
1	17-07-02	#3	9:54:25	10	35	--	--	--	--	33-----	S102-002350
2	17-07-02	#3	9:54:30	15	50	--	--	--	--	44-----	S102-002350
3	17-07-02	#3	9:54:35	10	35	10	19.5	--	--	1111----	S102-002350
4	17-07-02	#3	9:54:40	15	200	20	23.5	--	--	2222----	S102-002350
5	17-07-02	#3	9:54:45	--	175	--	5	--	--	-D-E---D	S102-002350
6	17-07-02	#3	9:54:50	0	0	0	20.9	0	0	-----	S102-002350
7	17-07-02	#3	9:54:55	2	7	14	20.2	0	0	--L----L	S102-002350
8	17-07-02	#3	9:55:00	11	37	34	20.2	0	0	LLH----M	S102-002350
9	17-07-02	#3	9:55:05	13	47	35	20.3	0	0	LLH----M	S102-002350
10	17-07-02	#3	9:55:10	13	59	13	20.3	0	0	LLL----M	S102-002350
11	17-07-02	#3	9:55:15	8	39	0	20.3	0	0	-L----L	S102-002350
12	17-07-02	#3	9:55:20	2	7	0	20.3	0	0	-----	S102-002350
13	17-07-02	#3	9:55:25	0	0	0	20.9	0	0	-----B-	S102-002350
14	17-07-02	#3	9:55:30	0	0	0	20.9	0	0	-----B-	S101-002350

Note

Some compatible software packages have an internal file size limit and may not load the entire file. Check software limits.

Descriptions of Line Examples

Line 1 TWA alarm setpoints (code 3) for H₂S and CO.

Line 2 STEL alarm setpoints (code 4) for H₂S and CO.

Line 3 low alarm setpoints (code 1) for all the sensors.

Line 4 high alarm setpoints (code 2) for all the sensors. Alarm points are only recorded when the detector is turned on, indicating the unit has just been activated.

Line 5 number of days remaining before calibration is due and the days since the last calibration.

Line 6 normal operation. There are no gas alarms.

Line 7 a combustible gas alarm. H₂S and CO gases are present below alarm levels. Oxygen is less than 20.9%, but within acceptable range. The detector is in low alarm.

Line 8-9 H₂S and CO in low alarm, and combustibles (0-100% LEL) in high alarm. Oxygen is less than 20.9% but within acceptable range. The detector is in multi-gas alarm.

Line 10 H₂S, CO, and combustibles (0-100% LEL) in low alarm. Oxygen is less than 20.9% but within acceptable range. The detector is in multi-gas alarm.

Line 11 CO in low alarm. Oxygen is less than 20.9%, but within acceptable range. H₂S is present below alarm levels. The detector is in low alarm.

Line 12 H₂S and CO present below alarm levels. Oxygen is less than 20.9% but within acceptable range. There are no gas alarms.

Line 13-14 detector emitting a low battery alarm. There are no gas alarms.

Maintenance

To maintain the detector in good operating condition, perform the following basic maintenance as required:

- Calibrate, bump test, and inspect the detector on a regular schedule.
- Maintain an operations log of all maintenance, calibrations, bump tests, and alarm events.
- Clean the exterior with a soft damp cloth. Do not use solvents, soaps, or polishes.
- Do not immerse the detector in liquids.

Inserting the MultiMediaCard (MMC)

The following figure illustrates how to insert the MMC card. To insert the MMC, complete the following:

1. Ensure the detector is deactivated.
2. Remove the battery tray and set aside. Refer to [Replacing the Batteries](#).
3. Refer to the following figure; insert the MMC card (label down; pins up) into the MMC card port.

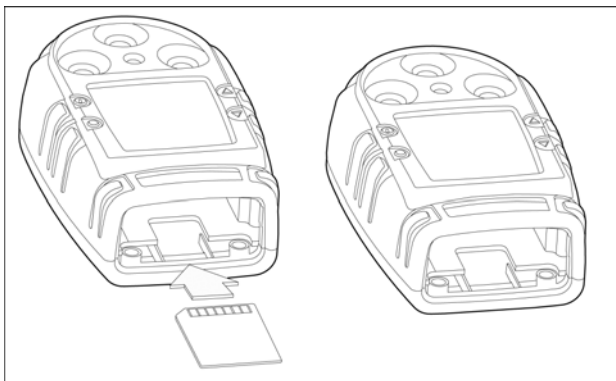

Figure 5. Inserting the MultiMediaCard (MMC)

4. Insert the battery tray back into the detector.

Replacing the Batteries

⚠ Warning

To avoid personal injury, adhere to the following:

- Replace the batteries as soon as the detector emits a low battery alarm.
- To prevent personal injury and/or damage to equipment, use only batteries that are recommended by BW Technologies. Refer to [Specifications](#) for a list of the approved batteries.
- Use only approved batteries that are properly installed in the battery tray.
- Charge the batteries using only a recommended charger. Do not use any other charger. Failure to observe this precaution can lead to a fire or an explosion.
- Do not change or charge batteries in a hazardous location. Doing so will impair the Intrinsic Safety of the unit and can cause a fire or explosion.

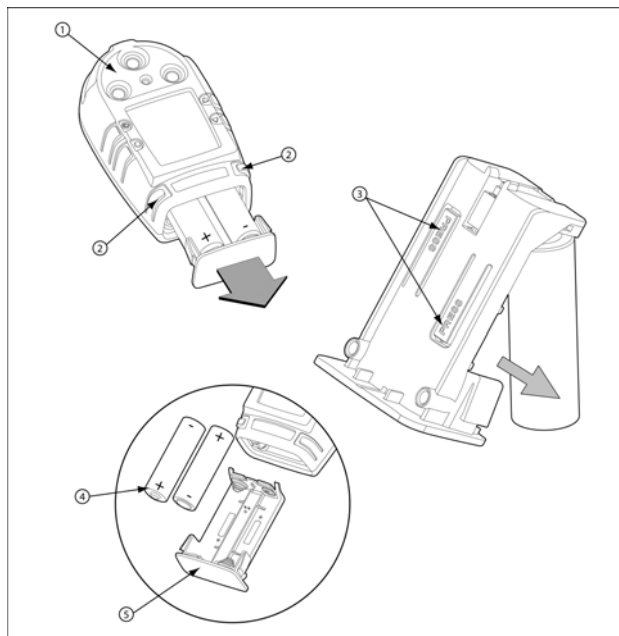

Figure 6. Replacing the Batteries

Table 13. Replacing the Batteries

Item	Description
1	Detector front
2	Release buttons
3	Press tabs
4	Batteries
5	Battery tray

To replace the batteries, complete the following:

1. Ensure the detector is deactivated.
2. Press the two release buttons on the bottom of the detector and pull out the battery tray.
3. Remove the batteries by pushing on the PRESS tabs located on the back of the battery tray.
4. Replace the batteries according to the polarity markings.
5. Replace the battery tray and push until the release tabs click.

Note

To preserve the life of the batteries, turn off the detector when not in use.

Replacing a Sensor or Sensor Filter

⚠ Warning

To avoid personal injury, use only sensors specifically designed for the detector. Refer to [Replacement Parts and Accessories](#).

Each sensor has a high degree of resistance to common vapors and gases. A sensor typically clears itself within 10-30 minutes in a clean atmosphere that is free of hazards.

Note

Do not expose a sensor to the vapors of inorganic solvents, such as paint fumes or organic solvents.

For additional information regarding sensors, refer to [Troubleshooting](#).

To replace a sensor or sensor filter, refer to the following procedures, table, and figure:

1. Ensure that the detector is deactivated.
2. Remove the battery tray (Figure 6) from the detector.
3. Remove the machine screw and alligator clip.
4. Remove the two thread cutting screws on the rear shell and remove the shell.

5. Remove the four thread cutting screws on the PCB assembly and extract the PCB.
6. Replace the sensor filter or sensor(s).

Note

Gently rock the sensor back and forth to remove a tightly held sensor.

Detectors that are configured for 1, 2, or 3 gases may contain a dummy sensor in one of the three sensor locations.

7. Re-assemble the detector.

Calibrate the detector after changing any sensor(s). Refer to [Calibration and Setting Alarm Setpoints](#).

Torque Specs for Replacing Plastic Housing

When replacing the plastic housing and attachments, ensure that the screws are not over tightened.

To prevent stripping the screws, refer to the following torque specifications.

Table 14. Torque Specs

Housing Assembly	Torque
PCB	3-4 in-lbs
Rear shell	3-4 in-lbs
Alligator clip	4-5 in-lbs

Table 15. Replacing a Sensor or Sensor Filter

Item	Description
1	Front shell
2	Triple sensor filter
3	Oxygen sensor (sensor 3)
4	LEL sensor (sensor 2)
5	CO/H ₂ S sensor (sensor 1)
6	Sensor locator
7	PCB assembly
8	Rear shell
9	Alligator clip
10	Machine screw
11	Thread cutting screws

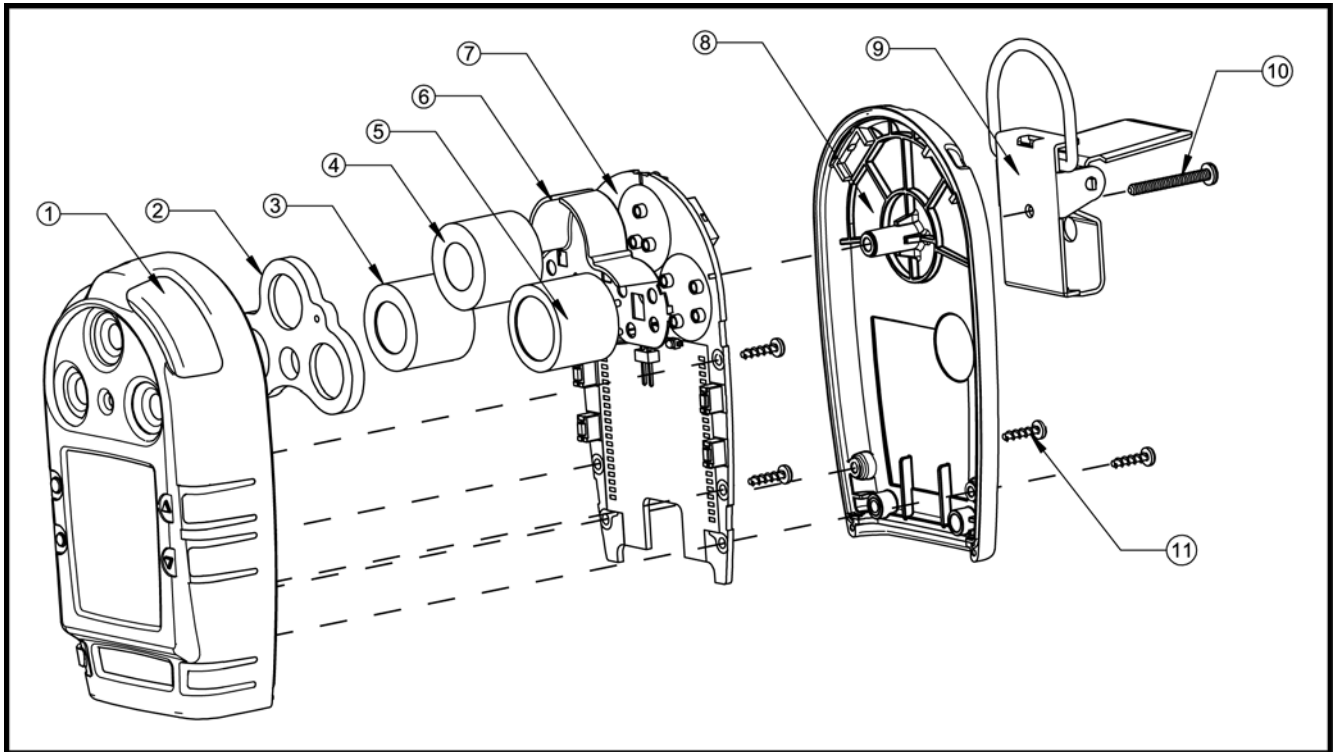

Figure 7. Replacing a Sensor or Sensor Filter

Troubleshooting

The detector's electronics are protected from variations in humidity and corrosive atmospheres. If you encounter a problem, try the solutions listed in the table below.

If you are still unable to correct the problem, contact [BW Technologies](#).

Table 16. Troubleshooting Tips

Problem	Possible Cause	Solution
The detector does not turn on.	→ No batteries → Depleted batteries → Damaged or defective detector	→ Install batteries (see Replacing the Batteries) → Replace batteries (see Replacing the Batteries) → Contact BW Technologies
The detector enters alarm immediately when it is turned on.	→ Sensor needs to stabilize → Low battery alarm → Sensor alarm	→ Used sensor: wait 60 seconds New sensor: wait 5 minutes → Replace batteries (see Replacing the Batteries) → Replace sensor (see Replacing a Sensor or Sensor Filter)
The activation self-test fails during one of the checks.	→ General fault	→ Contact BW Technologies

Table 16. Troubleshooting Tips (cont.)

Problem	Possible Cause	Solution
The detector does not display normal ambient gas reading after the activation self-test.	<ul style="list-style-type: none"> → Sensor not stabilized → Detector requires calibration → Target gas is present 	<ul style="list-style-type: none"> → Used sensor: wait 60 seconds New sensor: wait 5 minutes → Calibrate detector (see Calibration and Setting Alarm Setpoints) → Detector is operating properly. Use caution in suspect areas.
The detector does not respond to pushbuttons.	<ul style="list-style-type: none"> → Batteries are depleted → Detector is performing operations that do not require user input 	<ul style="list-style-type: none"> → Replace batteries (see Replacing the Batteries) → Pushbutton operation restored automatically when the operation ends
The detector does not accurately measure gas.	<ul style="list-style-type: none"> → Detector requires calibration → Detector is colder/hotter than ambient gas → Sensor filter is blocked 	<ul style="list-style-type: none"> → Calibrate sensor (see Calibration and Setting Alarm Setpoints) → Allow the detector to acquire ambient temperature before use → Clean the sensor filter (see Replacing a Sensor or Sensor Filter)

Table 16. Troubleshooting Tips (cont.)

Problem	Possible Cause	Solution
The detector does not enter alarm.	<ul style="list-style-type: none"> → Alarm setpoint(s) are set incorrectly → Alarm setpoint(s) set to zero → Detector is in calibration mode 	<ul style="list-style-type: none"> → Reset alarm setpoints (see Calibration and Setting Alarm Setpoints) → Reset alarm setpoints (see Calibration and Setting Alarm Setpoints) → Complete the calibration procedure
The detector intermittently enters alarm without apparent reason.	<ul style="list-style-type: none"> → Ambient gas levels are near alarm setpoint or the sensor is exposed to a puff of the target gas → Alarms set incorrectly → Missing or faulty sensor 	<ul style="list-style-type: none"> → Detector is operating normally. Use caution in suspect areas. Check maximum gas exposure reading. → Reset alarm setpoints (see Calibration and Setting Alarm Setpoints) → Replace sensor (see Replacing a Sensor or Sensor Filter)
The detector automatically shuts off.	<ul style="list-style-type: none"> → Automatic shutdown feature activated due to weak batteries 	<ul style="list-style-type: none"> → Replace batteries (see Replacing the Batteries)
The detector displays: IntErnAL cLock hAS FAiLEed	<ul style="list-style-type: none"> → General fault 	<ul style="list-style-type: none"> → Contact BW Technologies

Replacement Parts and Accessories

⚠ Warning

To avoid personal injury or damage to the detector, use only the specified replacement parts.

To order parts or accessories, contact [BW Technologies](#).

Table 17. Replacement Parts and Accessories

Model No.	Description	Qty
S4-W04	Replacement combustible sensor	1
S4-W04-SF	Replacement combustible sensor (with silicone filter)	1
SR-X10	Replacement O ₂ (2 year) sensor	1
D4-RHM04	Replacement twin tox H ₂ S/CO sensor	1
PS-RH04S	Replacement H ₂ S sensor (-3H units only)	1
PS-RS04	Replacement SO ₂ sensor	1
GAMIC-SS	Triple sensor filter replacement	2
CG-Q58-4	Quad calibration gas (58 l) (CH ₄ -2.5%, O ₂ -18.0%, H ₂ S-25 ppm, CO-100 ppm, bal.N ₂)	1

Model No.	Description	Qty
CG-Q34-4	Quad calibration gas (34 l) (CH ₄ -2.5%, O ₂ -18.0%, H ₂ S-25 ppm, CO-100 ppm, bal.N ₂)	1
CG-T34	Two gas calibration cylinder (34 l) 50% LEL (CH ₄ -2.5%) O ₂ - 20.9%, bal. N ₂	1
CG-S25	Calibration gas (58 l) SO ₂ -25 ppm, bal. N ₂	1
CG-BUMP-S25	SO ₂ bump test gas	1
CG-BUMP1	Bump alarm gas aerosol (CH ₄ -2.5%, O ₂ -10%, H ₂ S-40 ppm, CO-200 ppm)	1
REG-0.5	Regulator (0.5 l/min)	1
CK-Q34-4	Quad calibration kit with regulator, quad gas cylinder, hose, and carrying case	1
CK-Q58-4	Quad calibration kit with regulator, quad gas cylinder, hose, and carrying case	1
CR-MMC-FD1	FlashPath MMC card reader (3½" floppy disk adapter)	1
CG2-S-20-34	SO ₂ 20 ppm, balance N ₂ (34 l)	1
CG2-S-20-58	SO ₂ 20 ppm, balance N ₂ (58 l)	1

GasAlertMicro*User Manual*

Model No.	Description	Qty
SR-DUMM1	Dummy sensor (GAMIC-2 ver.)	1
REG-DF-1	Demand flow regulator (MicroDock)	1
REG-DF-2	Demand flow regulator for refillable cylinders, CGA connector	1
CR-MMC-USB1	MMC USB reader (USB port) with software for user-downloadable datalogger (-DL2)	1
MMC32	32 MB MultiMediaCard	1
MMC64	64 MB MultiMediaCard	1
GAMIC-C01-K	Kit of 4 AA NiMH rechargeable batteries and 110 VAC 4-port charger, American plug type)	1
GAMIC-C01-K-(xx)	230 VAC 4-port charger* and 4 AA NiMH batteries	1
GAMIC-C02	SMART Charger - 10-port, 110 VAC, American plug type	1
GAMIC-C03	GA MicroBatt Charger (cradle charger)	1
GAMIC-C03-K	GA MicroBatt Charger Kit with battery pack	1

Model No.	Description	Qty
GAMIC-V-CHRG1	Vehicle charger - 4-port, 12 volt with 4 AA NiMH rechargeable batteries	1
GAMIC-C05	GAMicro Charger II	1
GAMIC-C05-K	GAMicro Charger II kit	1
GAMIC-BAT-K	Rechargeable AA NiMH batteries, 1800 mAh, kit of 4 (not applicable for Europe)	1
GAMIC-BAT-K2	Rechargeable AA NiMH batteries, 1600 mAh, kit of 4	1
GAMIC-BAT-03	GA MicroBatt battery pack	1
GA-HMIC	Belt holster for GasAlertMicro	1
GA-HMIC-SP	Holster kit for GasAlertMicro and Sampler	1
GA-CH-2	Chest harness	1
GA-ES-1	Extension strap	1
GAMIC-TC-1	Calibration cap (standard)	1
GAMIC-TC-2	Calibration cap (single barb) for use with manual aspirator pump	1
GAMIC-AG2	Alligator clip (stainless steel)	1
GAMIC-CK-CC1	Carrying case with foam for GasAlertMicro confined space kits	1

Model No.	Description	Qty
GA-SPAK**	SamplerPak, motorized sampling pump portable kit	1
DOCK2-2-1B1C-00-N	MicroDock II base unit and module only	1
DOCK2-2-1B1C-02-N***	MicroDock II kit with 34 l calibration gas	1
DOCK2-2-1B1C-04-N***	MicroDock II kit with 58 l calibration gas	1
DOCK2-2-2B1C-00-N***	MicroDock II base unit and charging module only	1
DOCK2-2-2B1C-04-N***	MicroDock II charging kit with 58 l calibration gas	1
D4-AS01	Manual aspirator pump with 10 ft./3 m hose	1
GA-AS02	Manual aspirator pump with 1 ft./0.3 m probe	1
GA-TPROB6	Telescopic sample probe (6.5 ft./2 m)	1
M2437K	Battery lock screw, kit of 10 (applicable only for –UK, -EU and –AU detectors)	1
GAMIC-NC-1	Nylon case	1
GAMIC-LC-1	Leather case with neck strap	1

Model No.	Description	Qty
GAMIC-CK	GasAlertMicro confined space kit without detector	1
SP-CPROB1	Collapsible sample probe 3.3 ft./1 m)	1
GA-CDT	Portable product training video CD-ROM	1
M1806	Replacement tygon tube for sampling hoses	per ft.
D2067	GasAlertMicro English user manual	1
GAMIC-CDM	GasAlertMicro sampler CD-ROM – multi-language instructions and video	1

**Add suffix (-UK) for United Kingdom mains plug, (-EU) for European mains plug, (-AU) for Australian mains plug.*

***Add suffix (-UK) for United Kingdom mains plug and (-EU) for European mains plug.*

****Add suffix (-A) for Australia plug, (-CH) for Switzerland mains plug, (-E) for Europe mains plug, (-U) fur United Kingdom mains plug.*

Specifications

Instrument dimensions: 6 x 10 x 3.3 cm (2.4 x 4.0 x 1.3 in.)

Weight: 211 g (7.4 oz.)

Operating temperature: -20°C to +50°C (-4°F to +122°F)

Storage temperature: -20°C to +50°C (-4°F to +122°F)

Operating humidity: 5% to 95% relative humidity
(non-condensing)

Operating pressure: 95 to 110 kPa

Alarm setpoints: May vary by region and are user-settable

Detection range:

CO: 0-500 ppm in 1 ppm increments

H₂S, SO₂: 0-100 ppm in 1 ppm increments

O₂: 0-30% in 0.1% increments

Combustibles: field settable for:

0-100% LEL in 1% LEL increments or

0-5.0% v/v methane in 0.1% increments

Sensor type:

H₂S/CO: Twin plug-in electrochemical cell

O₂, SO₂, H₂S, CO Single plug-in electrochemical cell

Combustibles: Plug-in catalytic bead

O₂ measuring principle: Capillary controlled concentration sensor

Alarm conditions: TWA alarm, STEL alarm, low alarm, high alarm, multi-gas alarm, sensor alarm, low battery alarm, confidence beep, automatic shutdown alarm.

Audible alarm: 95 dB at 1 ft. (0.3 m) variable pulsed dual beepers

Visual alarm: Dual red light-emitting diodes (LED)

Display: Alphanumeric liquid crystal display (LCD)

Backlight: Automatically activates during alarm conditions and (if enabled) whenever there is insufficient light to view the display

Self-test: Initiated at activation

Calibration: Automatic zero and automatic span

Oxygen sensor: Automatic calibration upon activation (selectable)

User field options: Confidence beep, latching low and high alarms, pass code protection, enable/disable safe display mode, combustible sensor measurement (0-100% LEL or 0-5.0% v/v methane), sensor disable, set calibration due date, stealth mode, language selection, enable/disable automatic oxygen calibration, set span concentration values, set STEL calculation period, enable/disable automatic backlight, and distinguish use of the GA MicroBatt battery.

Datalogger models only: adjust clock calendar, set sampling rate, and enable/disable bump due note.

Approved Batteries:**North America**

Approved batteries for product (standards EN50020, UL913, C22.2 No. 157)

Alkaline:

Duracell MN1500	T3C (139.8°C)
Energizer E91	T3B (163°C)

NiMH rechargeable:

Quest Platinum HGAAC1800G	T2 (211.4°C)
Quest HG1600AACS	T3 (199°C)
Energizer NH15 1700 mAh	T2D (205°C)
Maha Powerex 1700 mAh MH-AA170	T3 (192°C)
Maha Powerex 1800 mAh MH-AA180	T2D (201.1°C)
Yuasa Delta 1300 mAh DHA1400AA	T2D (209°C)
Yuasa Delta 1500 mAh DHA1600AAC	T2D (204.4°C)
Uniross 1300 mAh	T3 (198°C)
Uniross 1700 mAh	T3 (186.8°C)

GA MicroBatt:

GAMIC-BAT-03	T4 (120°C)
GAMIC-BAT2-03	T4

Worst case temperature code:

Alkaline:	163°C
NiMH:	212°C
GA MicroBatt:	120°C
Ambient:	-20°C ≤ Ta ≤ +50°C

Europe

Approved batteries for product (standards EN50020)

Alkaline:

Duracell MN1500	Temperature Code T4 (129.8°C)
-----------------	----------------------------------

NiMH rechargeable:

Quest HG1600AACS	T3 (189°C)
Ambient:	-20°C ≤ Ta ≤ +40°C

GA MicroBatt:

GAMIC-BAT-03	T4 (120°C)
GAMIC-BAT2-03	T4
Ambient:	-20°C ≤ Ta ≤ +50°C

Battery charger (optional): Quest™ Q2 4-port rapid NiMH battery charger with country-specific mains adapter

First-time charge: 1-4 hours per battery

Normal charge: 1 hour per battery

Warranty: Full 2 year warranty including all sensors

Approvals: Approved by CSA to both U.S. and Canadian Standards.

Approved: Class I, Division 1, Group A, B, C, and D; Class I, Zone 0, Group IIC

Standards: CAN/CSA C22.2 No. 157 and C22.2 152
ANSI/UL – 913 and ANSI/ISA –S12.13 Part 1

CE (LCIE): EEx ia d IIC ATEX  II 1 G

ATEX: LCIE 03 ATEX 6091 X

BAM 04 ATEX 0002 X

It is recommended that BAM certified detectors be calibrated once every 90 days

IECEX

ABS type approved: VA-348-169-X

O₂ measuring function: BAM/ZBA/008/04

This equipment has been tested and found to comply with the limits for a Class B digital device, pursuant to Part 15 of the FCC Rules and ICES-003 Canadian EMI requirements. These limits are designed to provide reasonable protection against harmful interference in a residential installation. This equipment generates, uses, and can radiate radio frequency energy and, if not installed and used in accordance with the instructions, may cause harmful interferences to radio communications. However, there is no guarantee that interference will not occur in a particular installation. If this equipment does cause harmful interference with radio or television reception, which can be determined by turning the equipment off and on, the user is encouraged to try to correct the interference by one or more of the following measures:

- Reorient or relocate the receiving antenna.
- Increase the separation between the equipment and receiver.
- Connect the equipment into an outlet on a circuit different from that to which the receiver is connected.
- Consult the dealer or an experienced radio/TV technician for help.

General Specifications for Datalogger Units

Media type: MMC (MultiMediaCard)

Size: 32 MB (standard); 64 and 128 MB cards available

Storage: 500,000 lines of data available; 4.4 months at 5 second intervals (based on a normal workweek)

Memory type: Wrap-around memory ensures most recent data is always saved

Sample rate: One reading every 5 seconds (standard)

Data recorded: All sensor readings, all alarm conditions, calibrations, event flags, battery status, sensor status, confidence beep activation, and detector status along with the time and date for each reading and unit serial number

MMC card test: Automatically on activation

GasAlertMicro with User Downloadable Datalogger

Operation: Requires no user intervention (automatic)

Indicators: Icon advises Datalogger is operating normally, MMC missing/malfunction advise

Compatible with: Desktop PC computer or laptop

Operating system: Windows 95 or higher; Macintosh OS 8.6 or higher

Download via: MMC card reader

Card alarm: MMC fail or missing

Software required: Spreadsheet or database compatible with comma-separated-value (CSV) text files (Excel, Access, Quattro, etc.)

Support:

BW E.D.M (Excel Datalog Manager): E.D.M. is an Excel software add-in that enhances the abilities of Microsoft® Excel when handling GasAlertMicro User Downloadable Datalogger data files.

Fleet Manager Support CD: Fleet Manager is a software add-in used for GasAlertMicro User Downloadable Datalogger data files.

D2067/6 [English]

iERP: 117754

© BW Technologies 2006. All rights reserved. Printed in Canada.

All product names are trademarks of their respective companies.

